

ELEVATORS, AWLS, AND BONE HOOKS



SECTION G



To elevate, dissect, scrape and apply traction to bone and soft tissue.

CONTENTS

Elevators	1-16
Probes	2
Raspatories	4-5
Bone Awls	17-18
Bone Hooks	19-21

ORTHO+MED
The Surgical Instrument Specialists

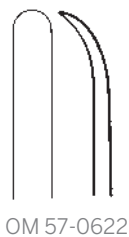
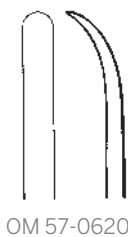

OM 57-0620

OM 57-0622

OM 57-0620 5 1/2" (140mm) semi-sharp 4mm
OM 57-0622 5 1/2" (140mm) semi-sharp 5mm

MCKENTY ELEVATOR



OM 57-0612
7" (178mm)
double ended
6mm semi-sharp end
and 5mm sharp end

OHL ELEVATOR



OM 57-0613
7 1/2" (191mm)
double ended
6.5mm sharp end
and 6.5mm blunt end

OM 57-0614
7 1/2" (191mm)
double ended
5mm sharp end
and 5mm blunt end

FREER ELEVATOR

5 1/2" (140mm) oval



OM 57-0616
7 1/2" (191mm)
double ended
8mm semi-sharp end
and 8mm blunt end

ALLERDYCE ELEVATOR AND DISSECTOR

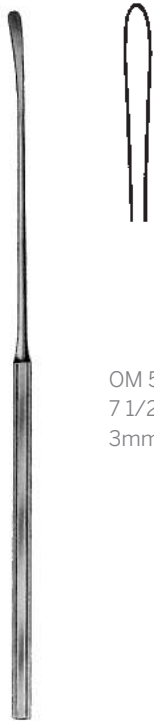

OM 57-0618
7 1/2" (191mm)
3mm blunt

SACHS NERVE ELEVATOR

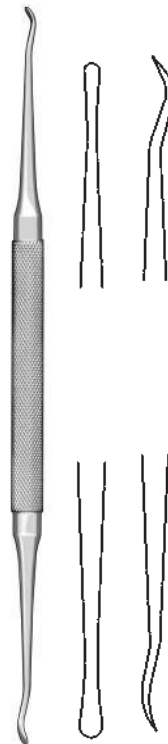

OM 57-0615
7 3/4" (195mm)
2mm x 3mm sharp ends

**KLEINERT KUTZ
ELEVATOR AND DISSECTOR**

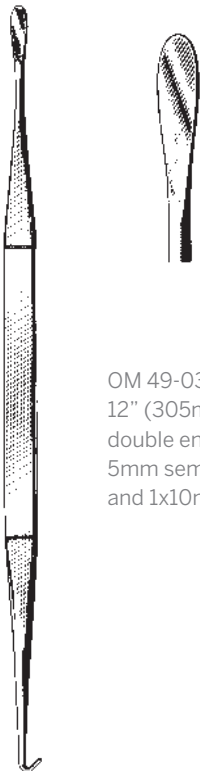

OM 49-0320
12" (305mm)
double ended
5mm semi-sharp end
and 1x10mm blunt hook

SMITHWICK HOOK AND DISSECTOR

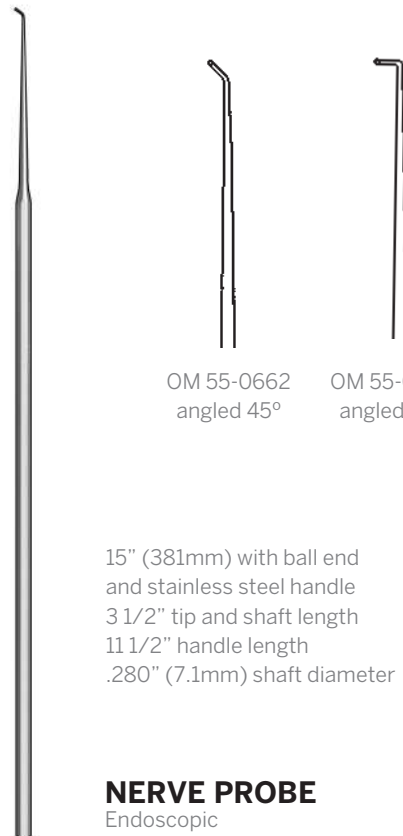

OM 55-0662 OM 55-0664
angled 45° angled 90°

15" (381mm) with ball end
and stainless steel handle
3 1/2" tip and shaft length
11 1/2" handle length
.280" (7.1mm) shaft diameter

NERVE PROBE
Endoscopic

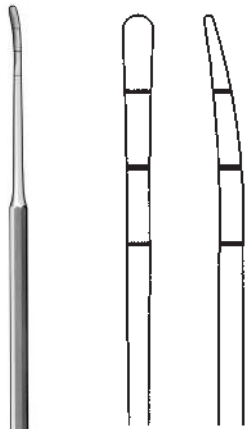

OM 55-0654
15" (381mm)
blunt with stainless steel handle
.16" (4mm) tip width
3 1/2" tip and shaft length
11 1/2" handle length
.280" (7.1mm) shaft diameter

PENFIELD ELEVATOR
Endoscopic

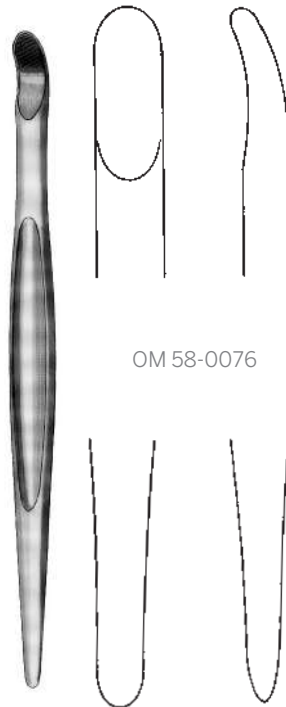

OM 58-0076

OM 58-0075
6 1/2" (165mm)
sharp, double ended
5mm end and
9mm end

OM 58-0076
6 1/2" (165mm)
blunt, double ended
5mm end and
9mm end

SAYRE PERIOSTEAL ELEVATOR

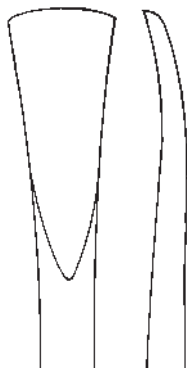

OM 49-0322
7 1/2" (191mm)
15mm sharp
curved edge

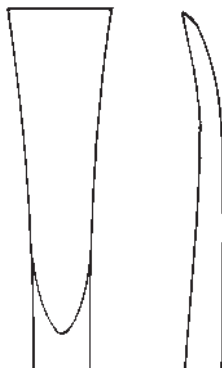

OM 49-0324
7 1/2" (191mm)
15mm sharp
straight edge

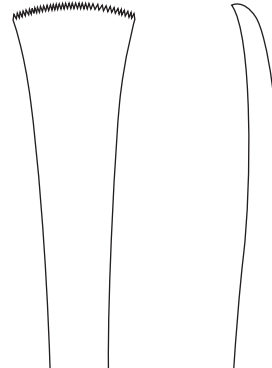

OM 49-0326
7 1/2" (191mm)
15mm serrated curved
edge

CUSHING PERIOSTEAL ELEVATOR

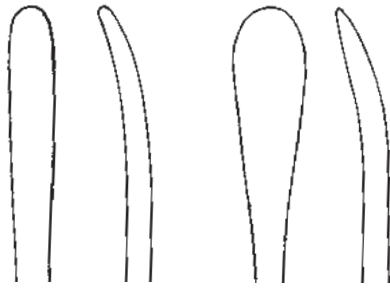

OM 46-0208

OM 46-0210

OM 46-0208
7 3/4" (195mm)
narrow
6mm blunt

OM 46-0210
7 3/4" (195mm)
broad
10mm blunt

LANE PERIOSTEAL ELEVATOR

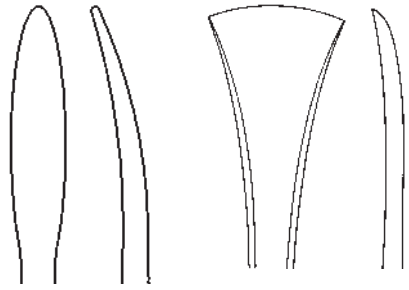

OM 46-0222

OM 46-0224

OM 46-0222
7 3/4" (195mm)
6mm narrow
blunt edge

OM 46-0224
7 3/4" (195mm)
17mm broad
sharp edge

LANGENBECK PERIOSTEAL ELEVATOR



OM 58-0085
7" (178mm)
16mm sharp

SEDILLOT PERIOSTEAL ELEVATOR

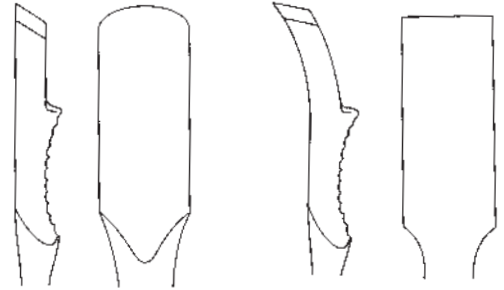

OM 58-0106

OM 58-0108

OM 58-0106
6" (152mm)
sharp
13mm curved edge
straight blade

OM 58-0108
6" (152mm)
sharp
13mm straight edge
curved blade

FARABEU PERIOSTEAL RASPATORY

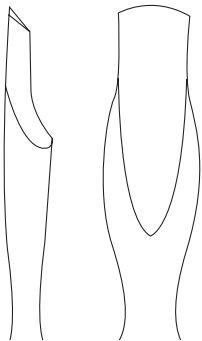

OM 58-0112
6 3/4" (172mm)
sharp

**KIRMISSION PERIOSTEAL
RASPATORY**

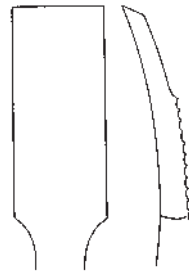

OM 58-0110
8" (203mm)
12mm sharp

**ALEXANDER PERIOSTEAL
RASPATORY**

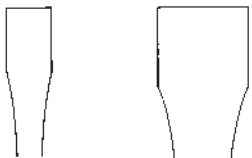

OM 46-0258 OM 46-0262

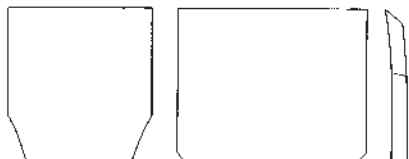

OM 46-0264 OM 46-0266

OM 46-0258	7"	1/4" width
OM 46-0260	7 1/2"	3/8" width
OM 46-0262	7 1/2"	1/2" width
OM 46-0263	7 1/2"	5/8" width
OM 46-0264	8"	3/4" width
OM 46-0266	8 1/4"	1" width

KEY PERIOSTEAL ELEVATOR
Sharp edge

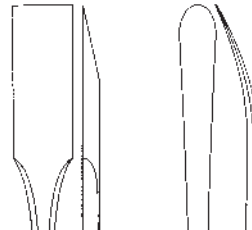

OM 49-0310 OM 49-0311

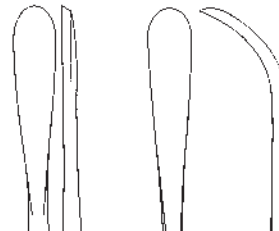

OM 49-0313 OM 49-0312

OM 49-0310	6 3/4" sharp	7mm	straight
OM 49-0311	6 3/4" blunt	7mm	curved
OM 49-0313	6 3/4" semi-sharp	7mm	straight
OM 49-0312	6 3/4" semi-sharp	7mm	curved

aka Joker Elevator

ADSON PERIOSTEAL ELEVATOR



*Phenolic handles
are autoclavable
to 290°F (143°C).*

OM 46-0206
7 1/4" (184mm)
sharp
3mm straight edge
curved blade
phenolic handle

PERIOSTEAL ELEVATOR



*Phenolic handles
are autoclavable
to 290°F (143°C).*

OM 46-0207
7 1/4" (184mm)
sharp
6mm straight edge
curved blade
phenolic handle

PERIOSTEAL ELEVATOR



*Phenolic handles
are autoclavable
to 290°F (143°C).*

OM 46-0211
7 1/4" (184mm)
sharp
6mm straight edge
straight blade
phenolic handle

PERIOSTEAL ELEVATOR



*Phenolic handles
are autoclavable
to 290°F (143°C).*

OM 46-0212
7 1/4" (184mm)
sharp
6mm round edge
curved blade
phenolic handle

PERIOSTEAL ELEVATOR



Phenolic handles are autoclavable to 290°F (143°C).

OM 46-0213
7 3/4" (195mm)
sharp
14mm oval edge
straight blade
phenolic handle

PERIOSTEAL ELEVATOR

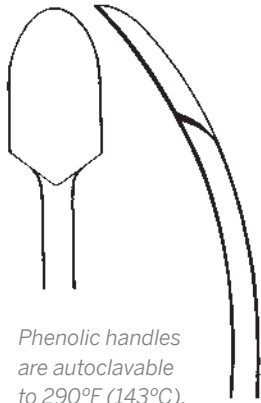

Phenolic handles are autoclavable to 290°F (143°C).

OM 46-0214
7 1/4" (184mm)
sharp
14mm oval edge
curved blade
phenolic handle

PERIOSTEAL ELEVATOR

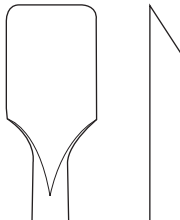

Phenolic handles are autoclavable to 290°F (143°C).

OM 46-0215
7 1/4" (184mm)
sharp
13mm straight edge
straight blade
phenolic handle

PERIOSTEAL ELEVATOR

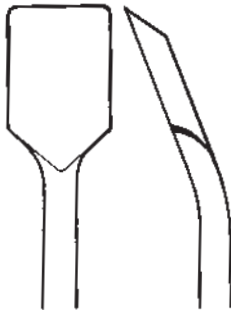

Phenolic handles are autoclavable to 290°F (143°C).

OM 46-0216
7 1/4" (184mm)
sharp
13mm straight edge
curved blade
phenolic handle

PERIOSTEAL ELEVATOR



Phenolic handles
are autoclavable
to 290°F (143°C).

OM 46-0217
7 1/4" (184mm)
sharp
20mm round edge
straight blade
phenolic handle

PERIOSTEAL ELEVATOR

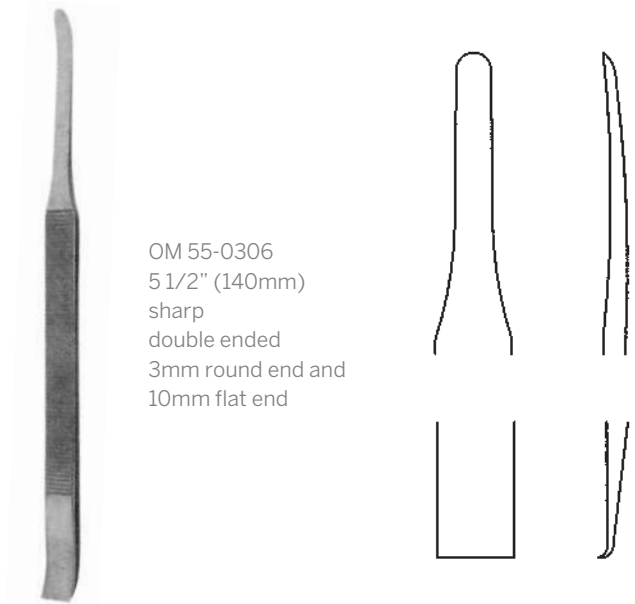

OM 55-0306
5 1/2" (140mm)
sharp
double ended
3mm round end and
10mm flat end

CARROLL PERIOSTEAL ELEVATOR

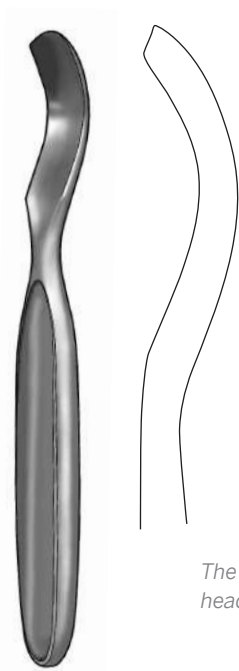

OM 69-0758
6 1/2" (165mm)
sharp
9mm

OM 69-0760
6 1/2" (165mm)
sharp
11mm

OM 69-0762
6 1/2" (165mm)
sharp
13mm

OM 69-0764
6 1/2" (165mm)
sharp
15mm

OM 69-0766
6 1/2" (165mm)
sharp
17mm

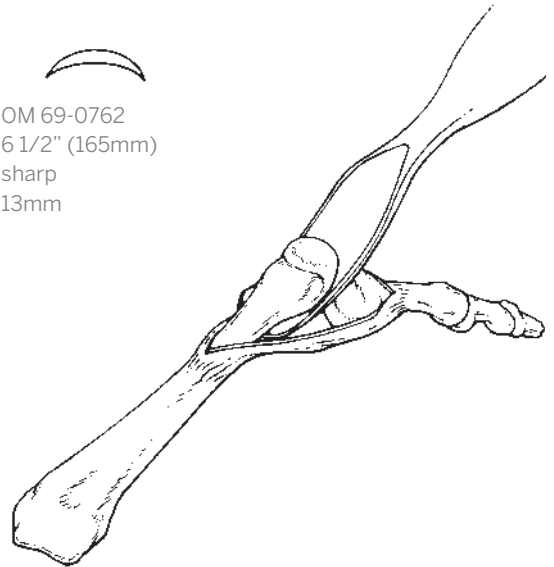

The McGlamry elevator is indispensable to deglove a metatarsal head. Also invaluable in numerous other procedures.

METATARSAL ELEVATOR

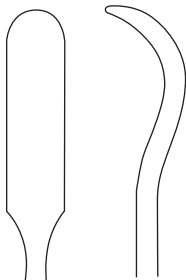

OM 46-0244
7 1/2" (191mm)
blunt
fully curved
width: 9/16" (15mm)

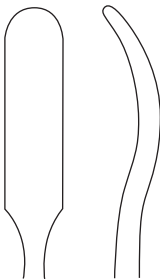

OM 46-0245
7 1/2" (191mm)
blunt
slightly curved
width: 9/16" (15mm)

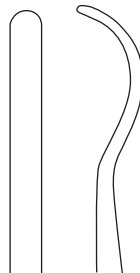

OM 46-0246
7 3/4" (185mm)
blunt
fully curved
width: 9/32" (7mm)

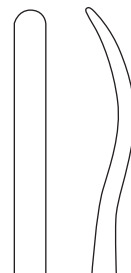

OM 46-0248
8" (203mm)
blunt
slightly curved
width: 9/32" (7mm)

CREGO PERIOSTEAL ELEVATOR

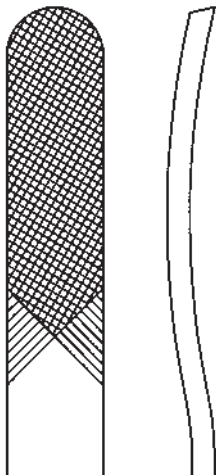

OM 46-0902

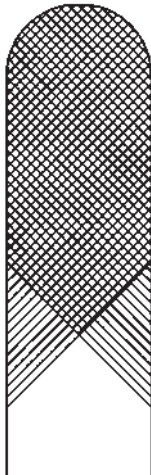

OM 46-0903

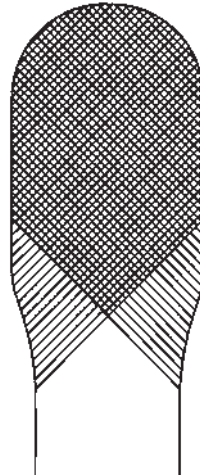

OM 46-0904

	width at tip	overall length	
OM 46-0901	3/8"	10 1/4" (260mm)	x-small
OM 46-0902	1/2"	10 1/4" (260mm)	small
OM 46-0903	3/4"	10 1/4" (260mm)	medium
OM 46-0905	1"	10 1/4" (260mm)	large
OM 46-0904	1"	13 3/4" (349mm)	x-large

DARRACH ELEVATOR
Blunt

Useful in shoulder surgery. Blunt tips with serrations can be used to elevate, or retract soft tissue and muscle from the operative site.

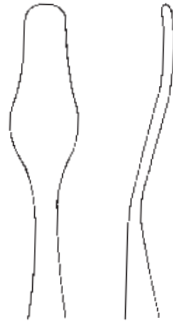

OM 46-0250

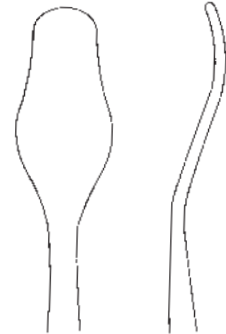

OM 46-0252

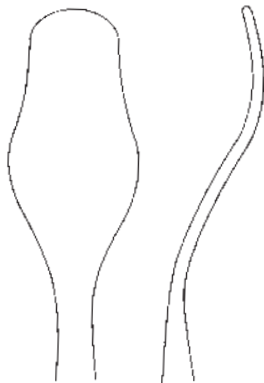

OM 46-0254

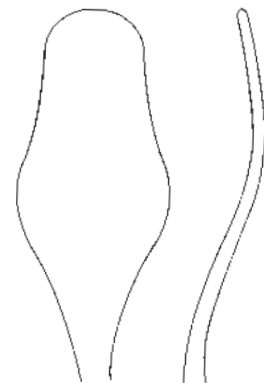

OM 46-0256

	width at tip	maximum width	overall length
OM 46-0250	8mm	13mm	7 1/2"
OM 46-0252	12mm	19mm	8"
OM 46-0254	17mm	25mm	9"
OM 46-0256	19mm	30mm	10"

CHANDLER ELEVATOR
Blunt



OM 49-0339
3/8" (10mm)



OM 49-0340
1/2" (13mm)



OM 49-0342
3/4" (19mm)



OM 49-0344
1" (25mm)

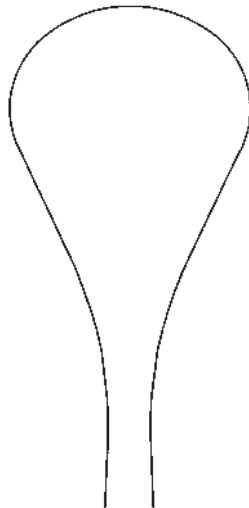

OM 49-0346
1 1/4" (32mm)

COBB SPINAL ELEVATOR

9 1/2" sharp
With hexagonal handle, all stainless steel



COBB ELEVATOR
Endoscopic with phenolic handle

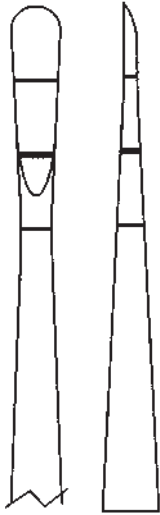

OM 55-0620
17" (432mm)
sharp
1/4" (6mm) tip width
2.7" tip length
9.3" shaft length
5" handle length
.285" (7.2mm) shaft diameter



OM 55-0610
20" (508mm)
sharp
1/4" (6mm) tip width
3 1/2" tip length
10" shaft length
6 1/2" handle length
.45" (11.5mm) shaft diameter



OM 55-0612
20" (508mm)
sharp
3/8" (10mm) tip width
3 1/2" tip length
10" shaft length
6 1/2" handle length
.45" (11.5mm) shaft diameter



OM 55-0614
20" (508mm)
sharp
.490" (13mm) tip width
3 1/2" tip length
10" shaft length
6 1/2" handle length
.45" (11.5mm) shaft diameter



HARRINGTON SPINAL ELEVATOR

OM 55-0798
12" (305mm) -
3/4" (19mm) Tip Width

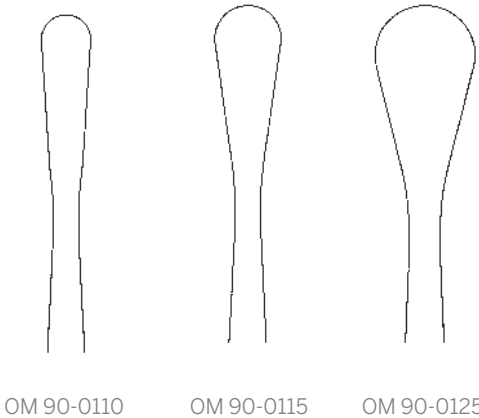

OM 90-0110

OM 90-0115

OM 90-0125

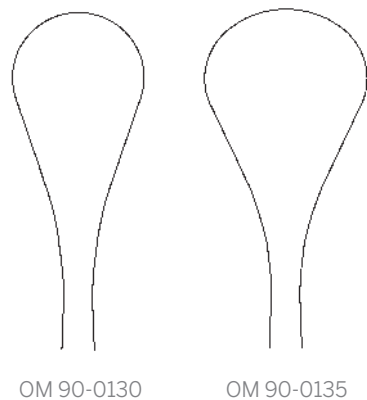

OM 90-0130

OM 90-0135

OM 90-0110 15" (381mm) overall with 9" (229mm) handle, 3/8" (10mm) width
OM 90-0115 15" (381mm) overall with 9" (229mm) handle, 1/2" (13mm) width
OM 90-0120 15" (381mm) overall with 9" (229mm) handle, 5/8" (16mm) width
OM 90-0125 15" (381mm) overall with 9" (229mm) handle, 3/4" (19mm) width
OM 90-0130 15" (381mm) overall with 9" (229mm) handle, 1" (25mm) width
OM 90-0135 15" (381mm) overall with 9" (229mm) handle, 1 1/4" (32mm) width

LONG COBB ELEVATOR
15" overall length with 9" handle



OM 90-0225
14" (360mm)

**LONG ELEVATOR
W/SILICONE HANDLE**
Endoscopic with silicone handle

1 3/8" wide (35mm)



OM 86-0132
12" (305mm)

FEMORAL HEAD ELEVATOR
with teeth

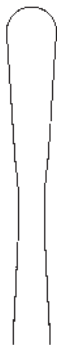

OM 46-0413S
3/8" (10mm)
all stainless steel

OM 46-0413
3/8" (10mm)
aluminum handle

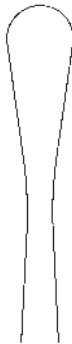

OM 46-0414S
1/2" (13mm)
all stainless steel

OM 46-0414
1/2" (13mm)
aluminum handle



OM 46-0416S
3/4" (19mm)
all stainless steel

OM 46-0416
3/4" (19mm)
aluminum handle



OM 46-0418S
1" (25mm)
all stainless steel

OM 46-0418
1" (25mm)
aluminum handle



OM 46-0420S
1 1/4" (32mm)
all stainless steel

OM 46-0420
1 1/4" (32mm)
aluminum handle

COBB SPINAL ELEVATOR
Endoscopic with handle

1 1/2" sharp all stainless steel. Also available with stainless steel working end and aluminum handle.

See Section AA for Cobb Rack.



OM 55-0300
10" (254mm) double ended
3mm semi-sharp end

**WOODSON ELEVATOR
AND SPATULA**



OM 55-0302
7" (178mm) double ended
with grooved blade
3mm blunt end

**WOODSON DURAL
SEPARATOR AND PACKER**

Phenolic handles are autoclavable to 290°F (143°C)

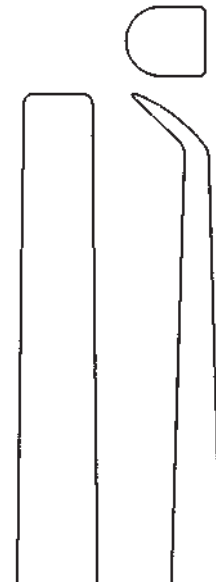

OM 55-0640
angled 45°

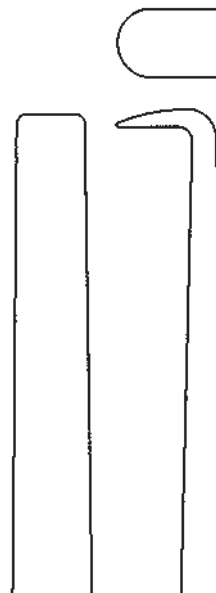

OM 55-0644
angled 90°

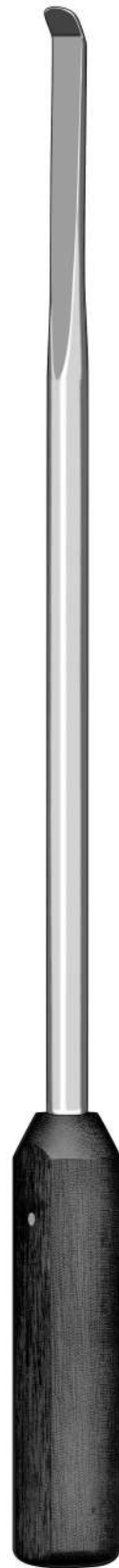

17" sharp with phenolic handle
9mm (432mm) radius tip
4" tip length
8" shaft length
5" handle length
.45" (11.5mm) shaft diameter

RIB ELEVATOR
Endoscopic

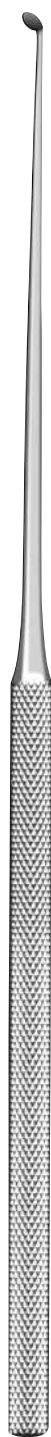

OM 55-0329	Container for Rhoton Set		
OM 55-0330	Round dissector	1mm	angled
OM 55-0331	Round dissector	2mm	angled
OM 55-0332	Round dissector	3mm	angled
OM 55-0333	Elevator curved		
OM 55-0334	Elevator angled		
OM 55-0335	Spatula dissector	#6 small	angled
OM 55-0336	Spatula dissector	#7 medium	angled
OM 55-0337	Spatula dissector	#8 large	angled
OM 55-0338	Hook 90°	sharp	angled
OM 55-0339	Hook 90°	blunt	angled
OM 55-0340	Hook 45°	sharp	angled
OM 55-0341	Needle	sharp	straight
OM 55-0342	Micro curette	1X2mm	straight
OM 55-0343	Micro curette	1X2mm	angled
OM 55-0344	Ball tipped dissector	0.8mm	
OM 55-0345	Ball tipped dissector	3mm	90°
OM 55-0346	Ball tipped dissector	5mm	90°
OM 55-0347	Ball tipped dissector	4mm	40°
OM 55-0348	Ball tipped dissector	8mm	40°

Titanium 7 1/2" (191mm)

OM 97-0260	Dissector titanium	1mm	blade round
OM 97-0261	Dissector titanium	2mm	blade round
OM 97-0262	Dissector titanium	3mm	blade round
OM 97-0263	Elevator titanium		curved
OM 97-0264	Elevator titanium		angled
OM 97-0265	Spatula dissector titanium		small
OM 97-0266	Spatula dissector titanium		medium
OM 97-0267	Spatula dissector titanium		large
OM 97-0268	Hook/needle titanium	90deg	semi-sharp
OM 97-0269	Hook/needle titanium	90deg	blunt
OM 97-0270	Hook/needle titanium	45deg	semi-sharp
OM 97-0271	Hook/needle titanium		straight
OM 97-0272	Curette titanium		straight
OM 97-0273	Curette titanium		angled
OM 97-0274	Ball-dissector titanium	90deg	3mm
OM 97-0276	Ball-dissector titanium		straight
OM 97-0277	Ball-dissector titanium	90deg	5mm
OM 97-0278	Ball-dissector titanium	40deg	4mm
OM 97-0279	Ball-dissector titanium	40deg	8mm

RHOTON MICRO DISSECTION INSTRUMENTS

7 1/2" (191mm)

ELEVATORS



OM 57-0624
7" (178mm)
Style 1
double ended

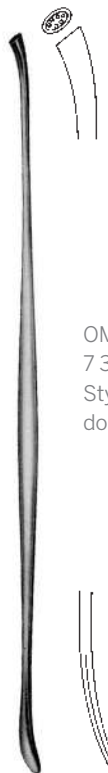

OM 57-0626
7 3/4" (195mm)
Style 2
double ended

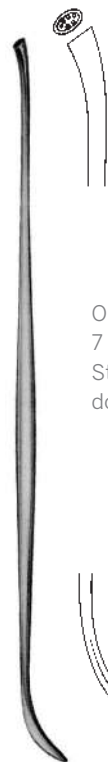

OM 57-0628
7 3/4" (195mm)
Style 3
double ended



OM 57-0630
8" (203mm)
Style 4
single ended

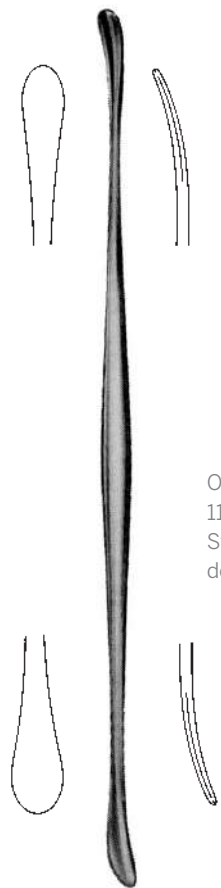

OM 57-0632
11 1/2" (292mm)
Style 5
double ended

PENFIELD ELEVATOR



OM 46-0916
9 1/4" (235mm)
phenolic handle

SHOULDER PENETRATING AWL

Phenolic handles are autoclavable to 290°F (143°C)

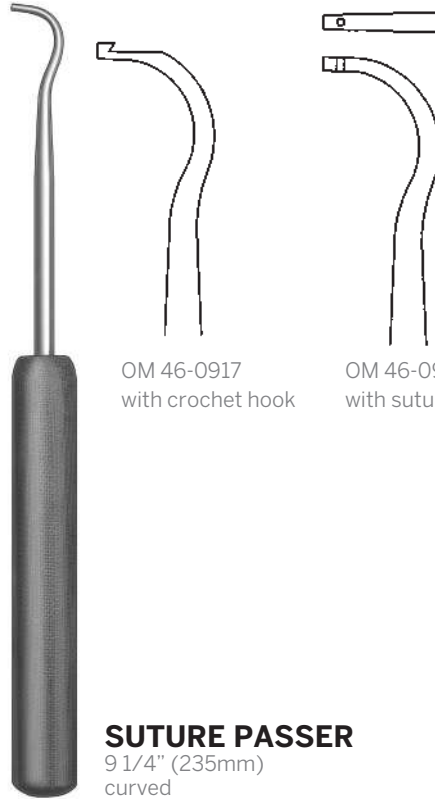

OM 46-0917
with crochet hook

OM 46-0918
with suture hole

SUTURE PASSER
9 1/4" (235mm)
curved

Used to pass sutures in shoulder surgery.

Phenolic handles are autoclavable to 290°F (143°C)

OM 48-0336
6 1/4" (159mm)
square taper



BONE AWL



OM 48-0337
8 1/4" (210mm)

PERTHES BONE AWL

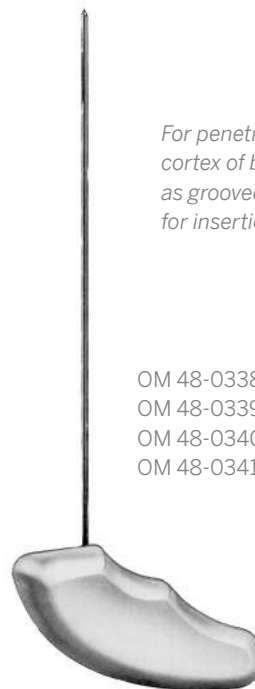

For penetrating cortex of bone. Used as grooved director for insertion of pins.

OM 48-0338	7 1/2"	working end	2.5mm dm
OM 48-0339	8 1/4"	working end	3mm dm
OM 48-0340	8 1/2"	working end	5mm dm
OM 48-0341	10 1/2"	working end	6mm dm

RUSH AWL AND REAMER



OM 48-0303
11" (280mm)
with handle

**KUNTSCHER DIAMOND
POINTED AWL**



OM 48-0588

BONE HOOK STOUT 6"

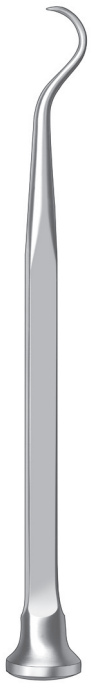

OM 46-0913
small



OM 46-0914
medium

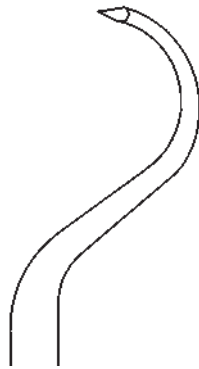

OM 46-0915
large

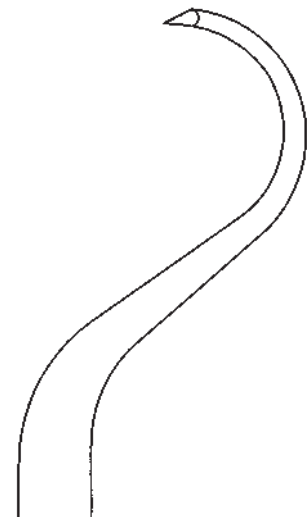

SHOULDER PERCUSSION AWL
8 1/2" (220mm)

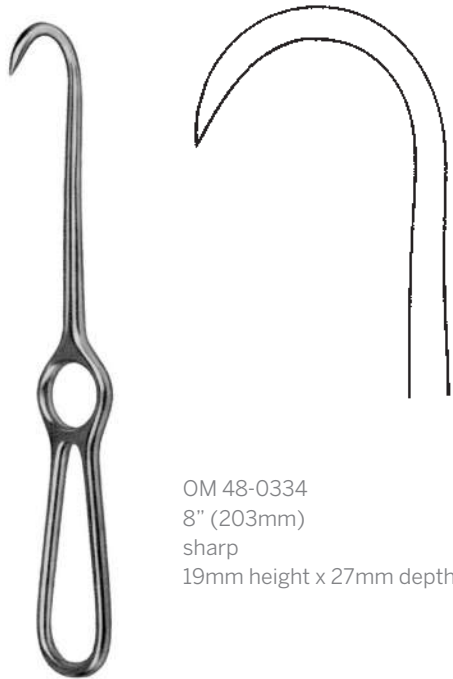

OM 48-0334
8" (203mm)
sharp
19mm height x 27mm depth

VOLKMAN BONE HOOK

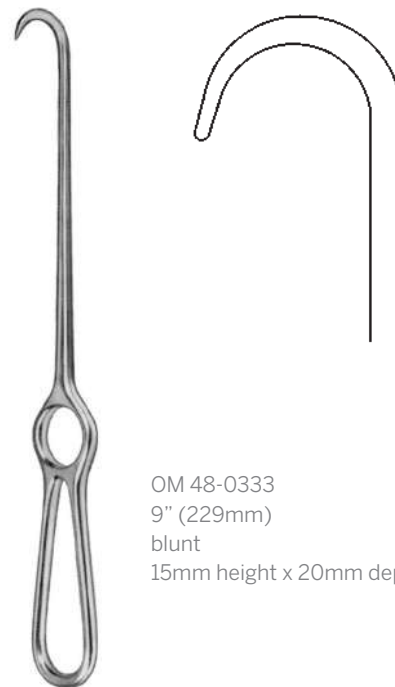

OM 48-0333
9" (229mm)
blunt
15mm height x 20mm depth

VOLKMAN BONE HOOK

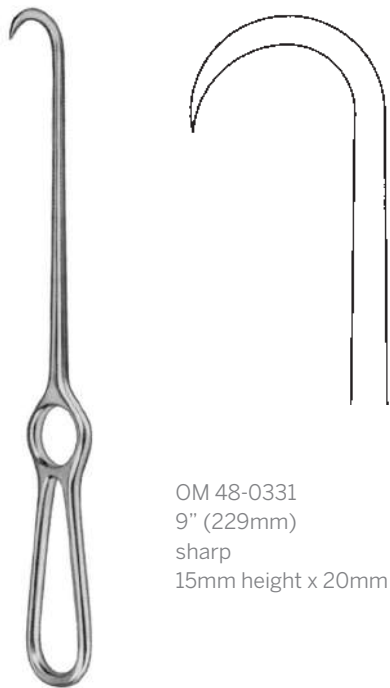

OM 48-0331
9" (229mm)
sharp
15mm height x 20mm depth

VOLKMAN BONE HOOK

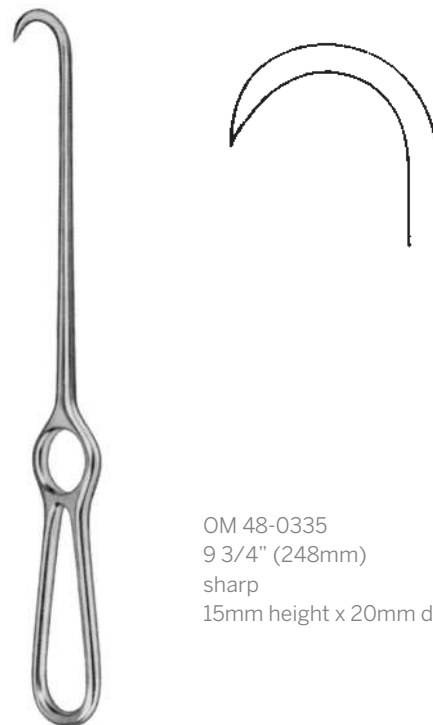

OM 48-0335
9 3/4" (248mm)
sharp
15mm height x 20mm depth

VOLKMAN BONE HOOK

BONE HOOKS



OM 48-0342

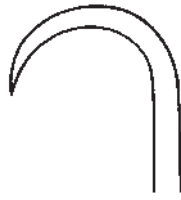

OM 48-0343



OM 48-0344

OM 48-0342
9" (229mm)
small 6mm height x 10mm depth

OM 48-0343
9" (229mm)
medium 11mm height x 18mm depth

OM 48-0344
9" (229mm)
large 12mm height x 21mm depth

BONE HOOK

Sharp with grip handle

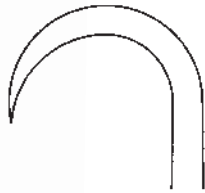

OM 48-0332
7" (178mm)
large, for femurs
18mm height x 21mm depth

BONE HOOK

Sharp with T-handle



OM 48-0345
10 1/2" (280mm)

SELF TAPPING FEMORAL HEAD REMOVER



OM 48-0583

LONG BONE HOOK
Blunt W/t-handle 10" Large



OM 48-0580 Large
10" (254mm)
10mm height x 40mm depth

LONG BONE HOOK
Sharp with Phenolic Handle