

SKIN HOOKS AND RETRACTORS



SECTION I



To retract, secure and apply traction to soft tissue and bone. To provide visualization and maintain wound exposure.

ORTHO+MED
The Surgical Instrument Specialists

CONTENTS

Skin Hooks	1-2
Finger Retractors	3-4
Retractors	5-17
Hip Retractors	18
Shoulder Retractors	19-26
Knee Retractors	26-27
Hohmann Retractors	28-32
Vickers Retractors	33
Self Retaining Retractors	34-52
Fiberoptic Retractors	53-54
Multi Trac Retractors	55-58
Femoral Spreaders	59-60
McCulloch Retractor	61-62



OM 52-0055
4 3/4" (121mm)
one sharp prong
2mm diameter

**ORTHOMED
SKIN HOOK**

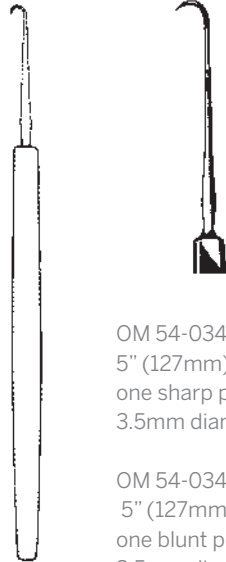

OM 54-0346
5" (127mm)
one sharp prong
3.5mm diameter

OM 54-0348
5" (127mm)
one blunt prong
3.5mm diameter

WIENER SKIN HOOK



OM 52-0050
5 1/2" (140mm)
one sharp prong
large deep curve
4mm diameter

COTTLE SKIN HOOK



OM 48-0158 OM 48-0161

OM 48-0158
5" (127mm)
one sharp prong
2.5mm diameter

OM 48-0161
5" (127mm)
one blunt prong
2.5mm diameter

FRAZIER HOOK



OM 54-0338 OM 54-0342

OM 54-0338
5" (127mm)
one sharp prong
1.5mm diameter

OM 54-0342
5" (127mm)
one blunt prong
1.5mm diameter

TYRELL HOOK



OM 54-0350
5" (127mm)
two sharp prongs
2.5mm wide

GUTHRIE HOOK

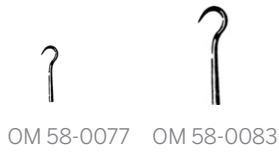

OM 58-0077
7" (178mm)
2mm diameter

OM 58-0083
7" (178mm)
3mm diameter

GILLIES HOOK



OM 52-0040
6" (152mm)
two sharp prong
2.5mm wide

OM 52-0042
6" (152mm)
two sharp prong
2.5mm wide

FREER SKIN HOOK



OM 52-0060 OM 52-0064

OM 52-0060 3mm diameter
OM 52-0064 5mm diameter
OM 52-0068 7mm diameter

KLEINERT-KUTZ HOOK

6" (152mm)

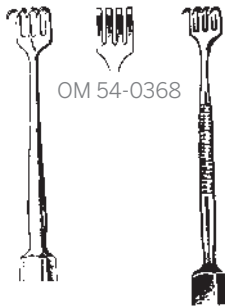

OM 54-0368

OM 54-0366 OM 54-0372

OM 54-0366 4 sharp prongs, rigid
OM 54-0368 4 blunt prongs, rigid
OM 54-0372 4 sharp prongs, flexible

BLAIR (ROLLET) RETRACTOR

5 1/2" (140mm) 6mm wide



OM 58-0091 OM 58-0092

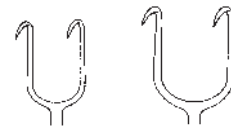

OM 58-0093 OM 58-0094

OM 58-0088 1 prong
OM 58-0091 2 prongs 2mm wide
OM 58-0092 2 prongs 5mm wide
OM 58-0093 2 prongs 7mm wide
OM 58-0094 2 prongs 10mm wide

JOSEPH HOOK

6 1/4" (159mm) sharp

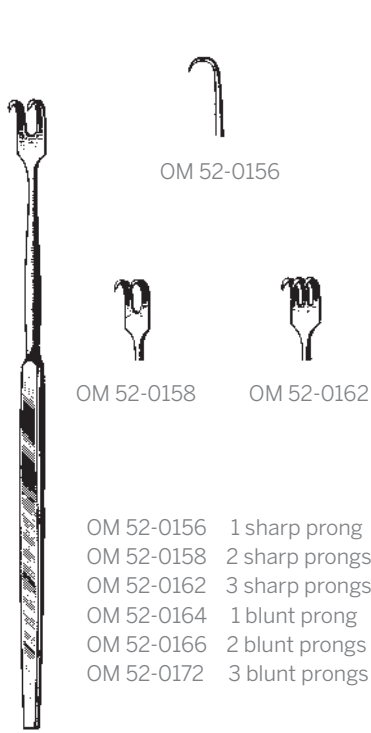

RIGID RAKE RETRACTOR

6 1/2" (165mm)

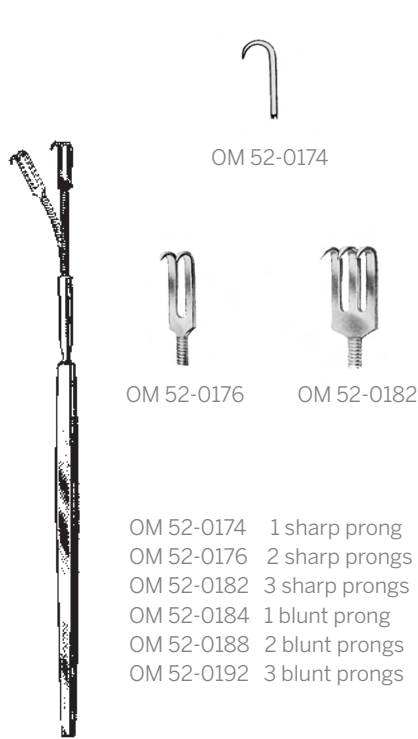

FLEXIBLE RAKE RETRACTOR

6 1/4" (159mm)



LAHEY RETRACTOR

4 3/4" (121mm)



VOLKMAN RETRACTOR

4 1/2" (114mm)

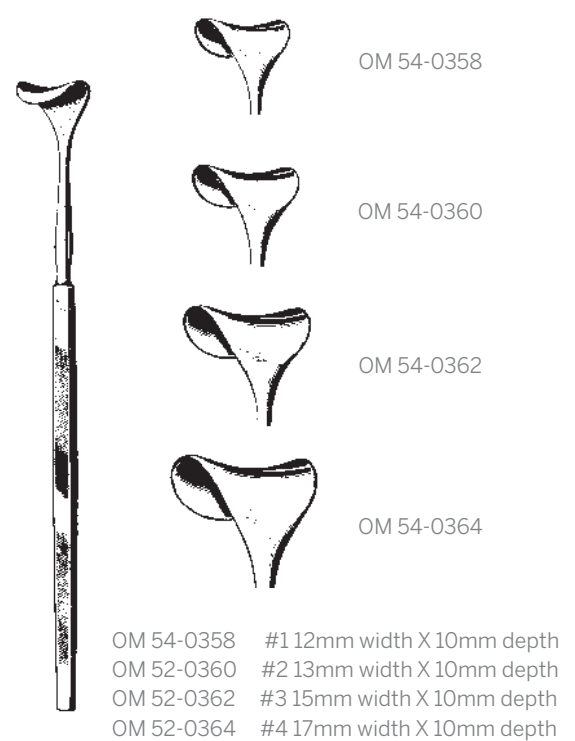

DESMARRES RETRACTOR

5 1/2" (140mm)

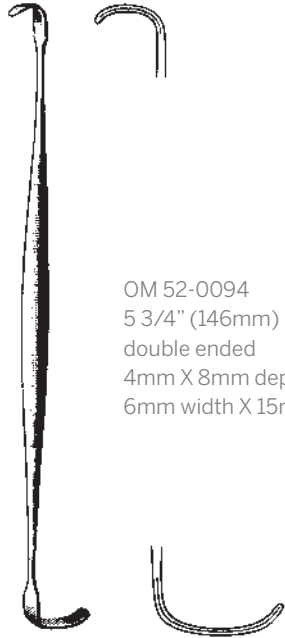

OM 52-0094
 5 3/4" (146mm)
 double ended
 4mm X 8mm depth blade and
 6mm width X 15mm depth blade

RAGNELL RETRACTOR

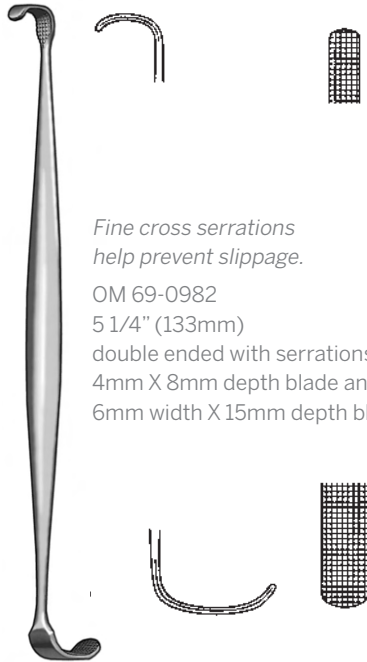

*Fine cross serrations
 help prevent slippage.*
 OM 69-0982
 5 1/4" (133mm)
 double ended with serrations
 4mm X 8mm depth blade and
 6mm width X 15mm depth blade

**RAGNELL-LINDE
 RETRACTOR**



OM 52-0076
 6" (152mm)
 double ended
 6mm X 17mm depth blade and
 9mm width X 20mm depth blade

DAVIS RETRACTOR

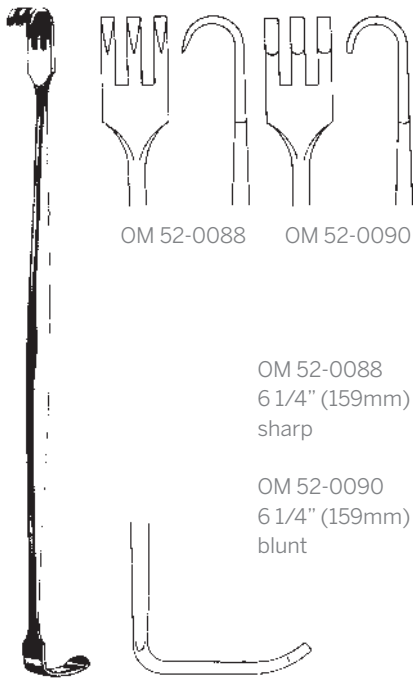

OM 52-0088 OM 52-0090

OM 52-0088
 6 1/4" (159mm)
 sharp

OM 52-0090
 6 1/4" (159mm)
 blunt

SENN RETRACTOR

3 prongs

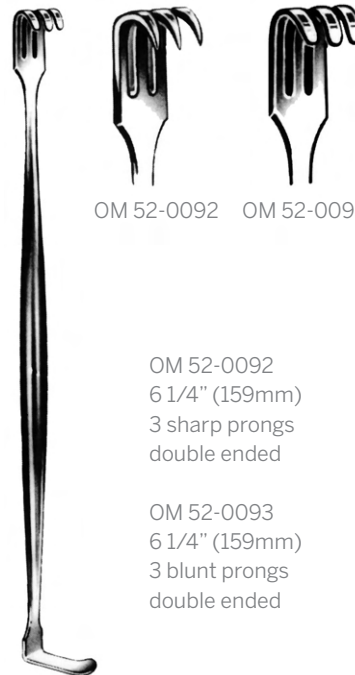

OM 52-0092 OM 52-0093

OM 52-0092
 6 1/4" (159mm)
 3 sharp prongs
 double ended

OM 52-0093
 6 1/4" (159mm)
 3 blunt prongs
 double ended

MATHIEU RETRACTOR

9mm width X 7mm depth prongs
 and 7mm width X 18mm depth blade

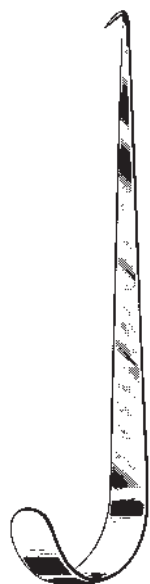

OM 52-0096
5 3/4" (146mm)
sharp

JACKSON TRACHEAL HOOK

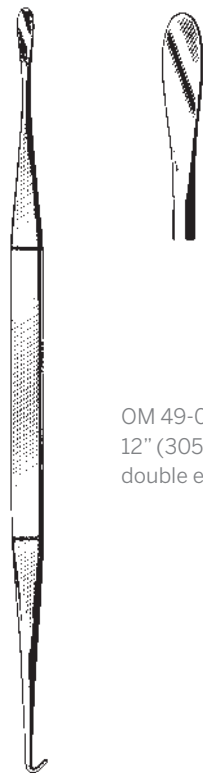

OM 49-0320
12" (305mm)
double ended

SMITHWICK HOOK AND DISSECTOR



OM 51-0468
4 3/8" (111mm)
double ended

CRILE RETRACTOR



OM 52-0116
#1



OM 52-0118
#2



OM 52-0122
#3



OM 52-0124
#4



OM 52-0128
#5



OM 52-0130
#6

MEYERDING FINGER RETRACTOR
7" (178mm)

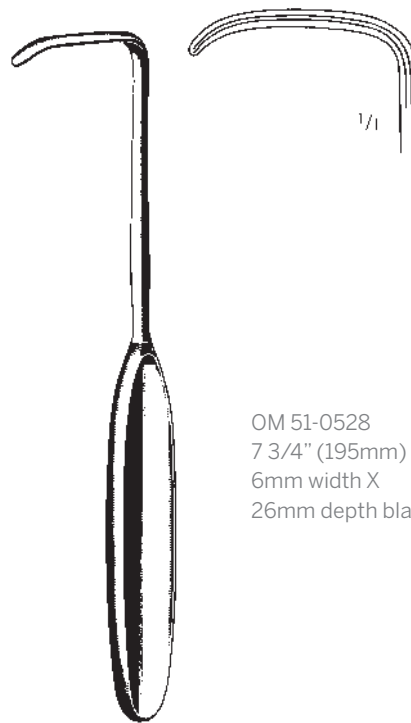

OM 51-0528
7 3/4" (195mm)
6mm width X
26mm depth blade

LAHEY RETRACTOR

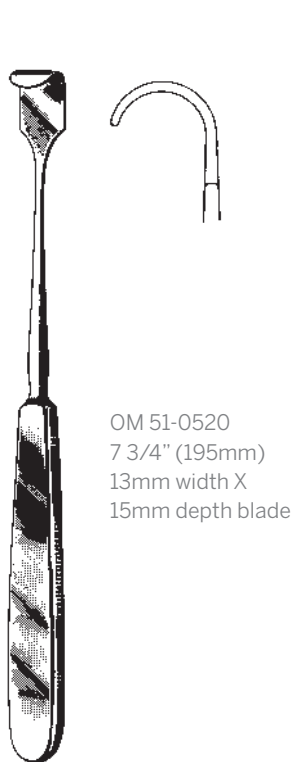

OM 51-0520
7 3/4" (195mm)
13mm width X
15mm depth blade

LITTLE RETRACTOR



OM 51-0524
8 1/2" (216mm)
fenestrated handle
20mm width X 23mm
depth blade

GREEN RETRACTOR



OM 55-0414 13mm width X 76mm without lip
OM 55-0415 18mm width X 76mm without lip
OM 55-0416 20mm width X 76mm without lip
OM 55-0417 23mm width X 76mm without lip
OM 55-0420 18mm width X 76mm depth blade
OM 55-0421 20mm width X 76mm depth blade
OM 55-0422 23mm width X 76mm depth blade

BLADE RETRACTOR

7 1/2" (191mm)



OM 51-0530

7mm width X 5mm depth
OM 51-0530 straight blade
OM 51-0532 angled 45° blade
OM 51-0534 angled 90° blade

LOVE NERVE RETRACTOR

8 1/2" (216mm)



OM 55-0426

OM 55-0426 8mm blade
OM 55-0428 13mm blade

**SCOVILLE NERVE
ROOT RETRACTOR**

9 1/4" (235mm) angled

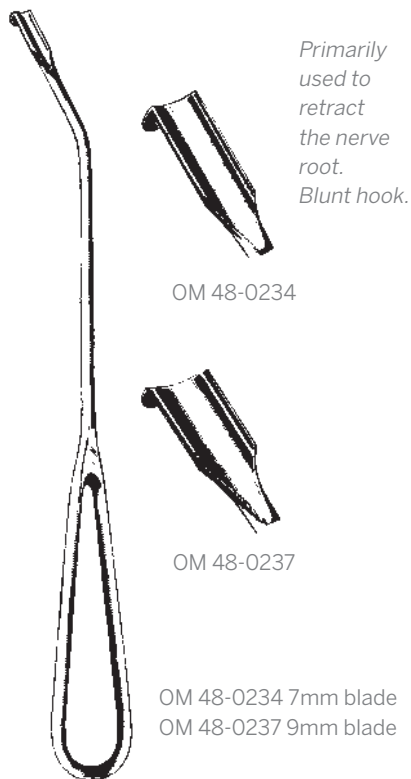

Primarily used to retract the nerve root. Blunt hook.

OM 48-0234

OM 48-0237

OM 48-0234 7mm blade
OM 48-0237 9mm blade

HOLSHER NERVE RETRACTOR
9 1/2" (241mm)



OM 47-0881
4mm blunt, straight right angle tip

DANDY NERVE HOOK
9" (229mm)

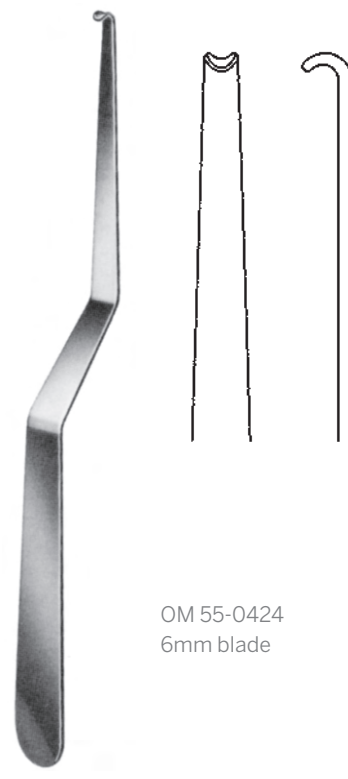

OM 55-0424
6mm blade

NERVE ROOT RETRACTOR
9" (229mm)



OM 51-0521
9" (229mm)
12mm width X
10mm depth blade
fenestrated handle

CUSHING VEIN RETRACTOR



OM 55-0304
8 3/4" (222mm)
13mm width X
22mm depth blade
fenestrated blade and handle

CUSHING DECOMPRESSION RETRACTOR



OM 97-0310 7 1/4" (184mm) Large 3mm
OM 97-0315 7 1/4" (184mm) Small 2mm
OM 97-0318 7 1/4" (184mm) Small Ball Tip
OM 97-0320 10 7/8" (276mm) Small Ball Tip
OM 97-0322 7 1/4" (184mm) Large Ball Tip

KRAYENBUEHL NERVE HOOK

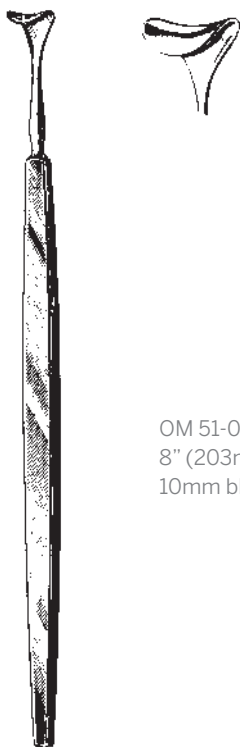

OM 51-0523
8" (203mm)
10mm blade

CUSHING VEIN RETRACTOR

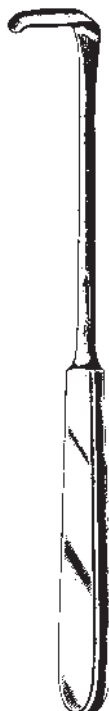

LANGENBECK RETRACTOR

8 3/4" (222mm)



OM 51-0100
#1
3/8" X 1 1/4"
(10 X 32mm)



OM 51-0104
#2
3/8" X 1 1/2"
(10 X 38mm)



OM 51-0112
#4
5/8" X 1 1/2"
(16 X 38mm)



OM 51-0108
#3
1/2" X 1 1/2"
(13 X 38mm)



OM EM1010 4 prong 28mm depth

VOLKMAN RETRACTOR



VOLKMAN RETRACTOR

8 1/2" (216mm) with ring handle

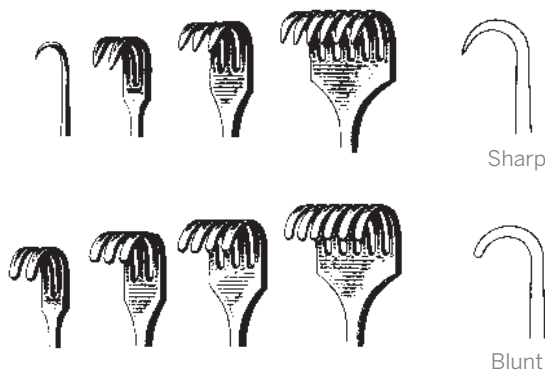

- Sharp**
- OM 52-0254 1 prong 10mm depth
 - OM 52-0258 2 prongs 8mm width X 10mm depth
 - OM 52-0262 3 prongs 13mm width X 10mm depth
 - OM 52-0264 4 prongs 18mm width X 10mm depth
 - OM 52-0266 6 prongs 28mm width X 10mm depth

- Blunt**
- OM 52-0268 2 prongs 8mm width X 10mm depth
 - OM 52-0272 3 prongs 13mm width X 10mm depth
 - OM 52-0274 4 prongs 18mm width X 10mm depth
 - OM 52-0276 6 prongs 28mm width X 10mm depth

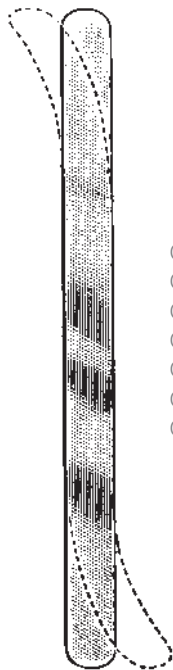

- OM 51-0752 6" X 1/2" (152mm X 13mm)
- OM 51-0755 7 1/2" X 1" (191mm X 25mm)
- OM 51-0766 13" X 3/4" (330mm X 19mm)
- OM 51-0768 13" X 1" (330mm X 25mm)
- OM 51-0770 13" X 1 1/4" (330mm X 32mm)
- OM 51-0772 13" X 1 1/2" (330mm X 38mm)
- OM 51-0776 13" X 2" (330mm X 51mm)

RIBBON RETRACTOR

Malleable

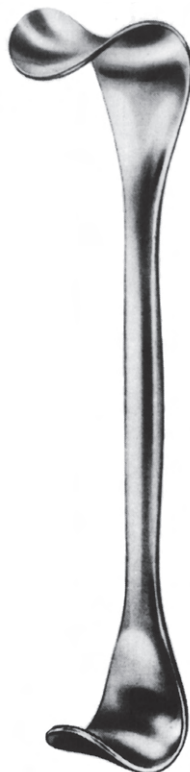

OM 51-0376
7 1/2" (191mm)
double ended

NERVE ROOT RETRACTOR

9" (229mm)



This variant of the Murphy Bone Skid features a strongly curved blade to better contour the humeral head. Serrations prevent slipping.

OM 46-0891
11" (280mm)
double ended, 20mm
and 30mm wide blades

SKID LEVER



OM 46-0892
12" (305mm)

MURPHY BONE SKID

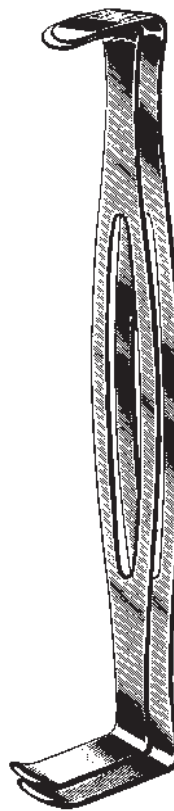

OM 51-0372
8 1/2" (216mm)
double ended, set of two
smaller: 15mm width X 25mm depth
and 15mm width X 30mm depth
larger: 15mm width X 37mm depth
and 15mm width X 42mm depth

U.S. ARMY RETRACTOR

OM 51-0059 25mm width X 50mm depth
OM 51-0060 26mm width X 75mm depth
OM 51-0061 25mm width X 100mm depth

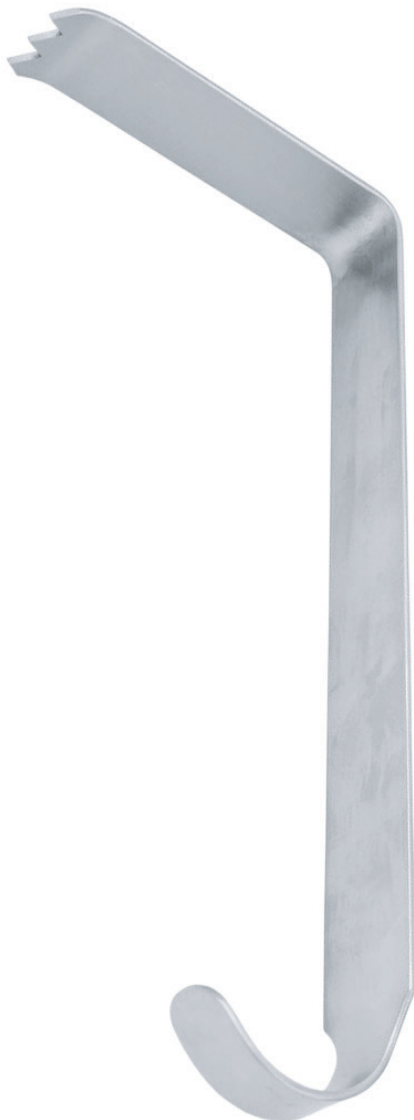
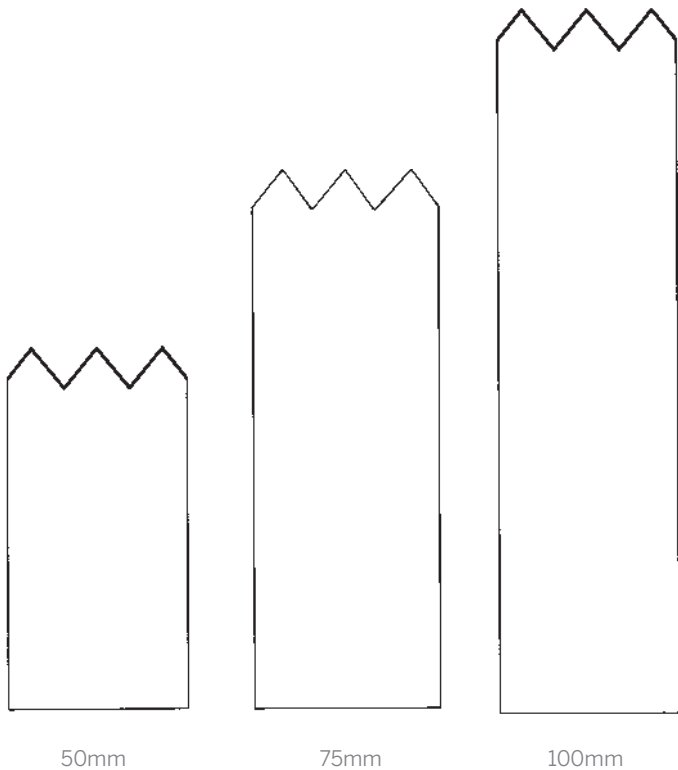

HIBBS RETRACTOR

9 1/2" (241mm) sharp teeth

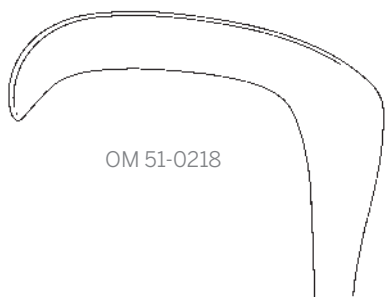

OM 51-0218



- OM 51-0216 1 1/2" X 2" blade
- OM 51-0218 2" X 2 1/2" blade
- OM 51-0220 2 1/2" X 3" blade
- OM 51-0222 3" X 3 1/2" blade

KELLY RETRACTOR

9 3/4" (248mm) with loop handle

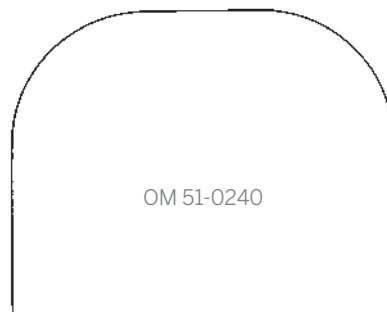

OM 51-0240



- OM 51-0230 1" wide X 10" long (25mm X 254mm)
- OM 51-0232 1" wide X 12" long (25mm X 305mm)
- OM 51-0234 1" wide X 13" long (25mm X 330mm)
- OM 51-0236 2 1/2" wide X 14 1/2" long (64mm X 368mm)
- OM 51-0238 3 1/2" wide X 12" long (89mm X 305mm)
- OM 51-0240 2" wide X 12" long (51mm X 305mm)
- OM 51-0242 3" wide X 12" long (76mm X 305mm)

DEAVER RETRACTOR

Hollow grip handle



DEAVER RETRACTOR PEDIATRIC

OM 51-0245 8 1/2" (216mm) 5/8" blade



DEAVER RETRACTOR

OM 51-0247 7" (178mm) 3/4" blade



DEAVER RETRACTOR PEDIATRIC

OM 51-0249 8 1/2" (216mm) 3/4" blade



DEAVER RETRACTOR

OM 51-0251 9" (229mm) 1" blade



DEAVER RETRACTOR PEDIATRIC

OM 51-0253 11 1/2" (292mm) 1 1/2" blade



DEAVER RETRACTOR
OM 51-0255 12" (305mm) 1" blade



DEAVER RETRACTOR
OM 51-0257 12" (305mm) 1 1/2" blade



DEAVER RETRACTOR
OM 51-0259 13" (330mm) 1" blade



DEAVER RETRACTOR
OM 51-0261 12" (305mm) 2" blade



DEAVER RETRACTOR
OM 51-0263 12" (305mm) 3" blade

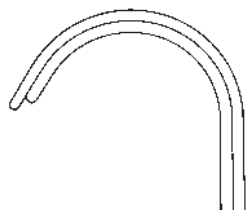
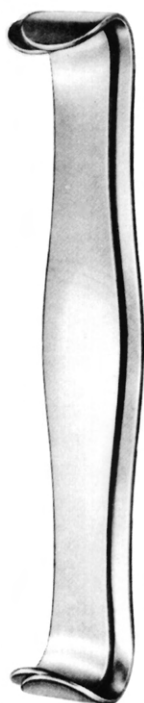

OM 51-0480
5" (127mm)
set

OM 51-0482
7 1/4" (184mm)
set

PARKER RETRACTOR

Double ended, set of two

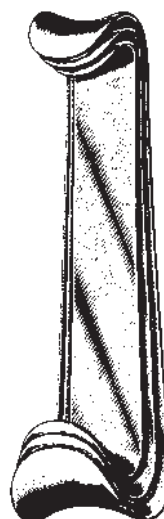

- OM 51-0498 5 1/4" (133mm) small
3/4" X 1" (19mm X 25mm)
- OM 51-0500 5 3/4" (146mm) medium
7/8" X 1 3/8" (22mm X 35mm)
- OM 51-0502 6 5/8" (173mm) large
1" X 1 5/8" (25mm X 41mm)

ROUX RETRACTOR

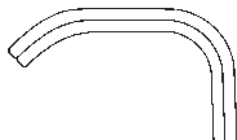

OM 51-0388
6" (152mm)
double ended
set of two

MAYO-COLLINS RETRACTOR

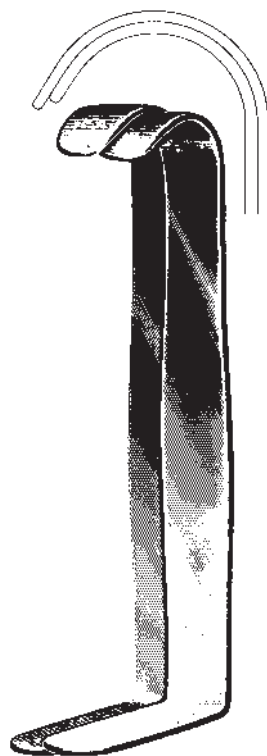

OM 51-0494
6" (152mm)
double ended
set of two

PARKER-MOTT RETRACTOR

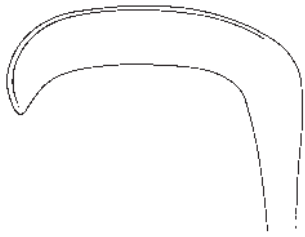

OM 51-0200 3/4" wide X 1" long blade
(19mm wide X 25mm long blade)
OM 51-0202 1" wide X 1 1/4" long blade
(25mm wide X 32mm long blade)
OM 51-0204 1 1/2" wide X 1 1/2" long blade
(38mm wide X 38mm long blade)

RICHARDSON RETRACTOR
9 1/2" (241mm)



OM 51-0206 9 1/2" (241mm)
3/4" wide X 2" long blade
(19mm wide X 51mm long blade)

RICHARDSON RETRACTOR



OM 51-0212 9 1/2" (241mm) small
OM 51-0214 10 1/4" (260mm) large
OM 51-0210 set of two

RICHARDSON-EASTMANN RETRACTOR

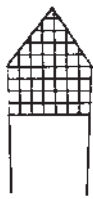

OM 48-0208
serrated pointed tip
10mm



OM 48-0214
smooth pointed tip
10mm

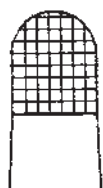

OM 48-0210
serrated blunt tip
10mm



OM 48-0212
smooth blunt tip
10mm



AUFRANC COBRA RETRACTOR

10 1/2" with hollow handle, 1 1/4" blade width



OM 90-6130
12" (305mm) Blade at widest 33mm

COBRA RETRACTOR

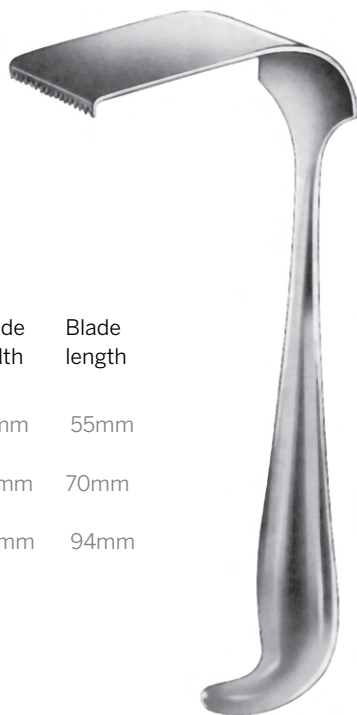

	Blade width	Blade length
OM 51-0158 9" small	17mm	55mm
OM 51-0162 9" medium	25mm	70mm
OM 51-0164 10" large	50mm	94mm

MEYERDING LAMINECTOMY RETRACTOR

Sharp teeth



OM 46-0880



OM 46-0880
10" (254mm) small
1 3/4" blade width

OM 46-0884
10" (254mm) large
2 1/2" blade width

BENNETT BONE ELEVATOR AND RETRACTOR

Hollow handle



OM 52-0282
9" (229mm)
4 blunt prongs
56mm width X
40mm depth

OLLIER RAKE RETRACTOR



OM 51-0078

OM 51-0078
9 1/2" (241mm)
3 blunt prongs
30mm width X 37mm depth

OM 51-0080
9 1/2" (241mm)
4 blunt prongs
40mm width X 40mm depth

ISRAEL RAKE RETRACTOR



OM 86-0129
13" (330mm)

**MUELLER TYPER FEMORAL
NECK RETRACTOR W/
KNURLED HANDLE**



OM 90-6320

SINGLE PRONG BROAD
Acetabular Retractor 12"



OM 52-0292 2 1/4" width X 1 1/2" depth
OM 52-0294 2 1/4" width X 2" depth
OM 52-0296 2 1/4" width X 2 1/2" depth
OM 52-0298 2 1/4" width X 3" depth

DEEP RAKE RETRACTOR
10 1/2" (267mm) with 4 blunt prongs

Note: These instruments are used to improve the exposure of the femoral canal prior to reaming or rasping for femoral prosthesis. Designed to elevate the proximal femur while retracting tissue during total or hemi-arthroplasty. The design provides excellent access to the intermedullary canal. The serrations at the tip grip and elevate the proximal femur.



OM 86-0130
13" (330mm)
50mm wide at tip, 68mm wide at
widest point of retractor blade.

FEMORAL NECK RETRACTOR



OM 86-0135
13" (330mm)
30mm wide at tip, 72mm wide at
widest point of retractor blade.
Blade is slightly concave.

FEMORAL NECK RETRACTOR
with suction hole



OM 90-7650-02
15 1/4" (387mm)
38mm blade width
6 1/4" (159mm) handle

FEMORAL NECK ELEVATOR
with extra leverage

*Used to expose the
acetabulum of the
right hip.*



OM 86-0140
10" (254mm) X 50mm

**INFERO-POSTERIOR
ACETABULAR CAPSULE
RETRACTOR**

Right

*Used to expose the
acetabulum of the
left hip.*



OM 86-0145
10" (254mm) X 50mm

**INFERO-POSTERIOR
ACETABULAR CAPSULE
RETRACTOR**

Left



OM 86-0137
19" (483mm),
tip 1 1/8" (28.5mm)
Serrated Upside Tip

BERTHA HIP RETRACTOR
with handle

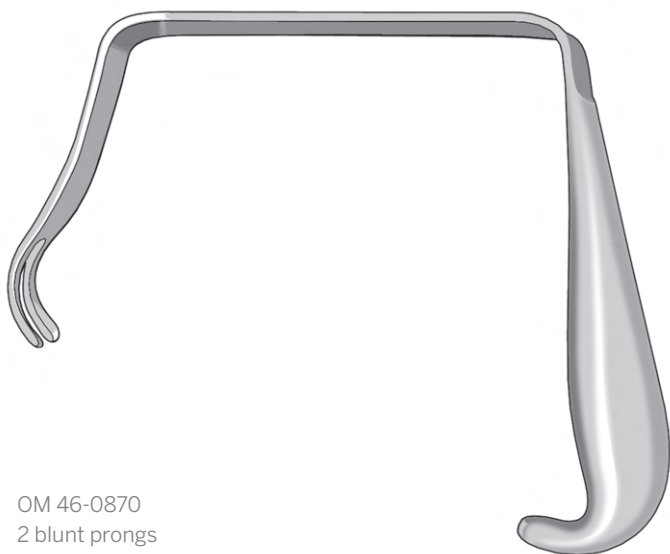

OM 46-0870
2 blunt prongs
25mm width X 102mm depth

BRISTOW/BANKART HUMERAL RETRACTOR



OM 46-0908
10" (254mm) with 3 sharp prongs
22mm blade width

CAPSULE RETRACTOR

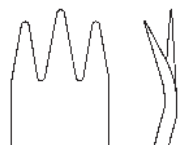

OM 46-0872
7 1/2" (191mm) with 3 blunt prongs
21mm blade width

**BRISTOW/BANKART
SOFT TISSUE RETRACTOR**

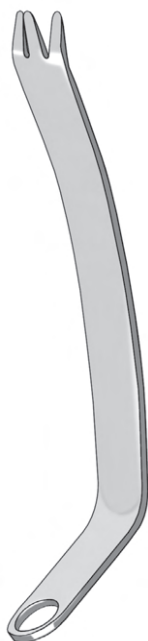

OM 46-0926 10 3/4" (273mm) small
OM 46-0927 10 3/4" (273mm) large

BROWNE DELTOID RETRACTOR

Modification to the original Fukuda design incorporates an additional forward bend at the distal 15mm. This allows the retractor to sit firmly on the posterior neck of the glenoid and reduces the chance of glenoid rim fractures. A series of shallow atraumatic grooves around the rim of the fenestration improves traction.

OM 46-0909
10" (255mm)
30mm wide blade

OM 46-0910
10" (255mm)
35mm wide blade



**MODIFIED FUDUKA
HUMERAL HEAD RETRACTOR**

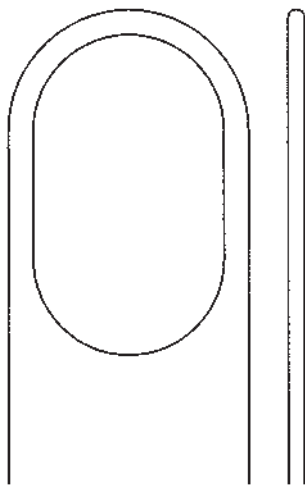

OM 46-0907
32mm width X 81mm length blade

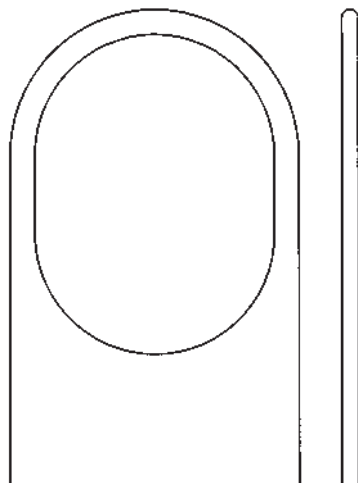

OM 46-0906
38mm width X 81mm length blade



FUKUDA STYLE SHOULDER RETRACTOR
7" (178mm)

Designed to gain optimal access to the subacromial space by distracting inferiorly the humeral head from the acromium. Perfect for massive tears and repair of a supraspinatus tear.

OM 86-0005
7" (178mm) long
right

OM 86-0010
7" (178mm) long
left

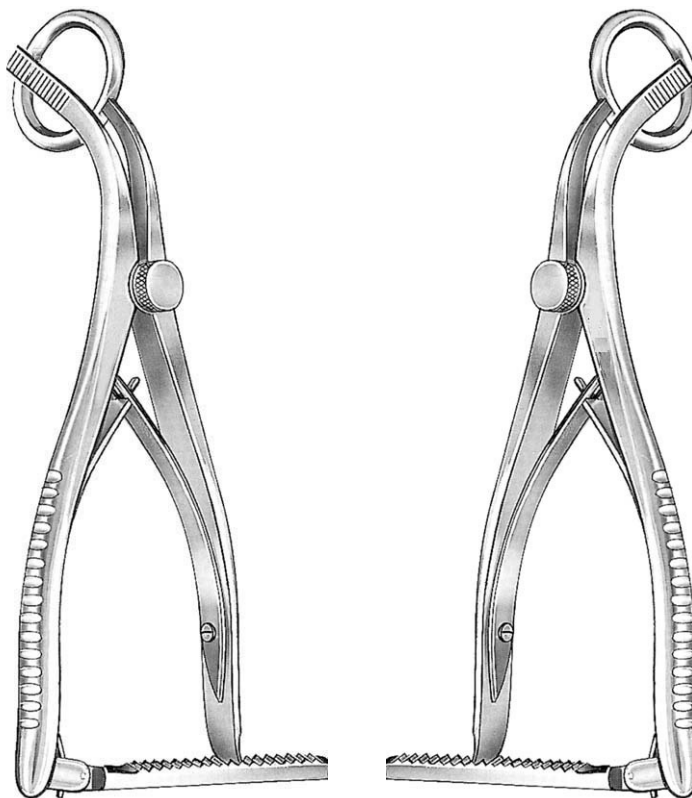

SUBACROMIAL RETRACTOR

The Goldstein retractor is placed along the glenoid rim during open Bankart Procedures to allow excellent exposure. The advantage this has over existing retractors is that the convex teeth sit easily into the glenoid rim while the strong end of the shaft allows the instrument to stay out of the surgeons view.

OM 86-0015
9" (229mm)
18mm wide tip

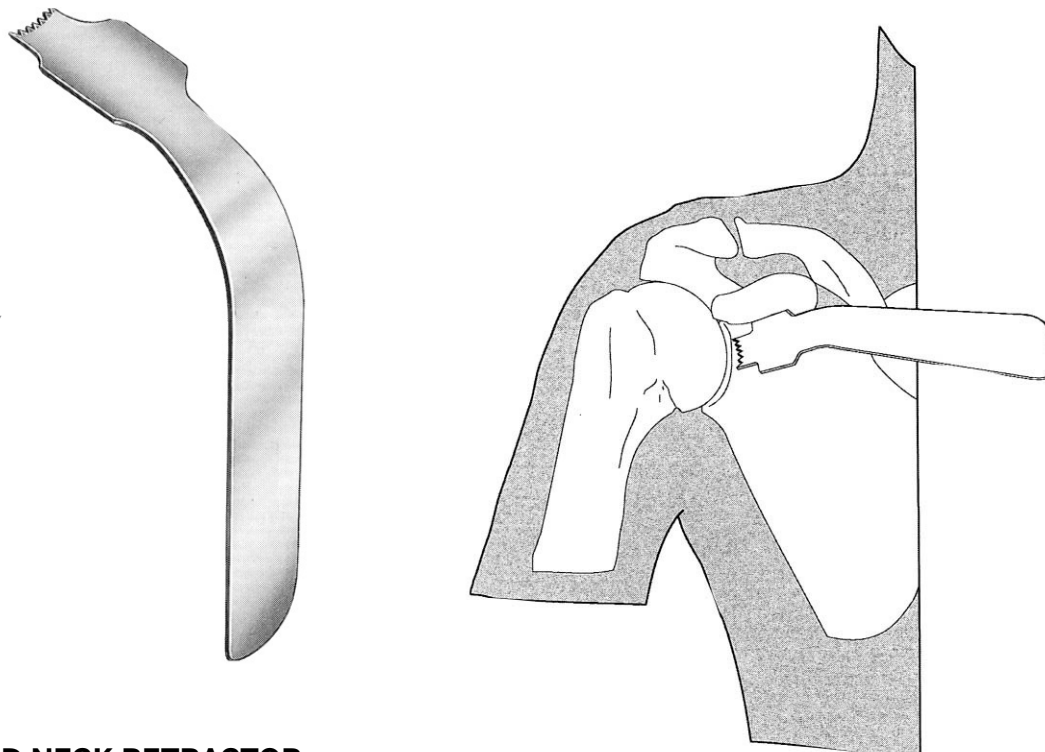

GOLDSTEIN GLENOID NECK RETRACTOR

The retractor's teeth are specifically designed to retract the subscapularis and capsule medially during a Bankart procedure. The wide midsection retracts the soft tissue during anterior glenoid work. The curved handle allows the assistant to use minimal pressure to achieve exposure.

OM 86-0030
11" (279mm) long X 25mm tip

**ANTERIOR GLENOID
NECK RETRACTOR**



Used during osteotomy of the humeral head and approaches to the glenoid. It is designed to allow one finger retraction and contours to allow teeth to fit behind the glenoid, retracting tissue for easy access to the glenoid.

OM 86-0025
10" (254mm) long X 30mm

**POSTERIOR GLENOID
NECK RETRACTOR**



Fits easily under the acromium, deltoid and over the humeral head. Used in most open procedures.

OM 86-0020
8" (203mm) long X 30mm

DELTOID RETRACTOR

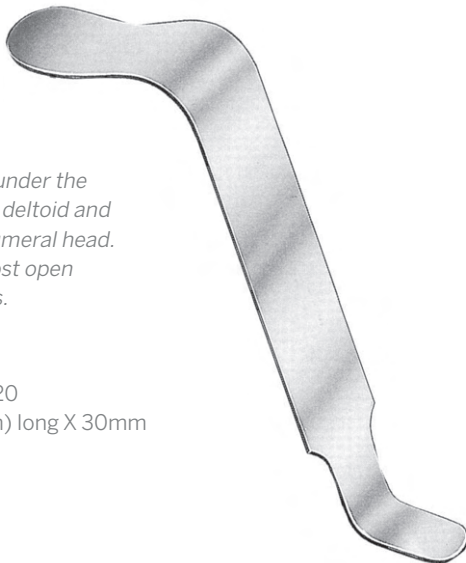

This retractor is placed between the glenoid and the humeral head to obtain excellent exposure. The two prongs wrap around the posterior rim to help distribute the applied force to the glenoid neck.

OM 86-0035
7" (180mm) strong curve

HUMERAL HEAD RETRACTOR



OM 86-0098
8 1/4" (209mm)



KOLBEL RETRACTOR

OM 86-0099
8 1/4" (209mm)



KOLBEL RETRACTOR RING HANDLE 8" HINGED



OM 86-0050

OM 86-0050
20mm X 36mm pair
popular in early stages and small incision procedures



OM 86-0055

OM 86-0055
20mm X 53mm pair
popular in early stages and small incision procedures



OM 86-0060

OM 86-0060
20mm X 68mm pair
popular in early stages and small incision procedures



OM 86-0065

OM 86-0065
20mm X 85mm pair
for larger muscle patients



OM 86-0070

OM 86-0070
36mm X 36mm pair
standard size, most popular



OM 86-0075

OM 86-0075
36mm X 53mm pair
standard size, most popular



OM 86-0080

OM 86-0080
36mm X 68mm pair
standard size, most popular



OM 86-0085

OM 86-0085
36mm X 85mm pair
for larger muscle patients

KOLBEL RETRACTOR BLADES

Pairs, 2 blades

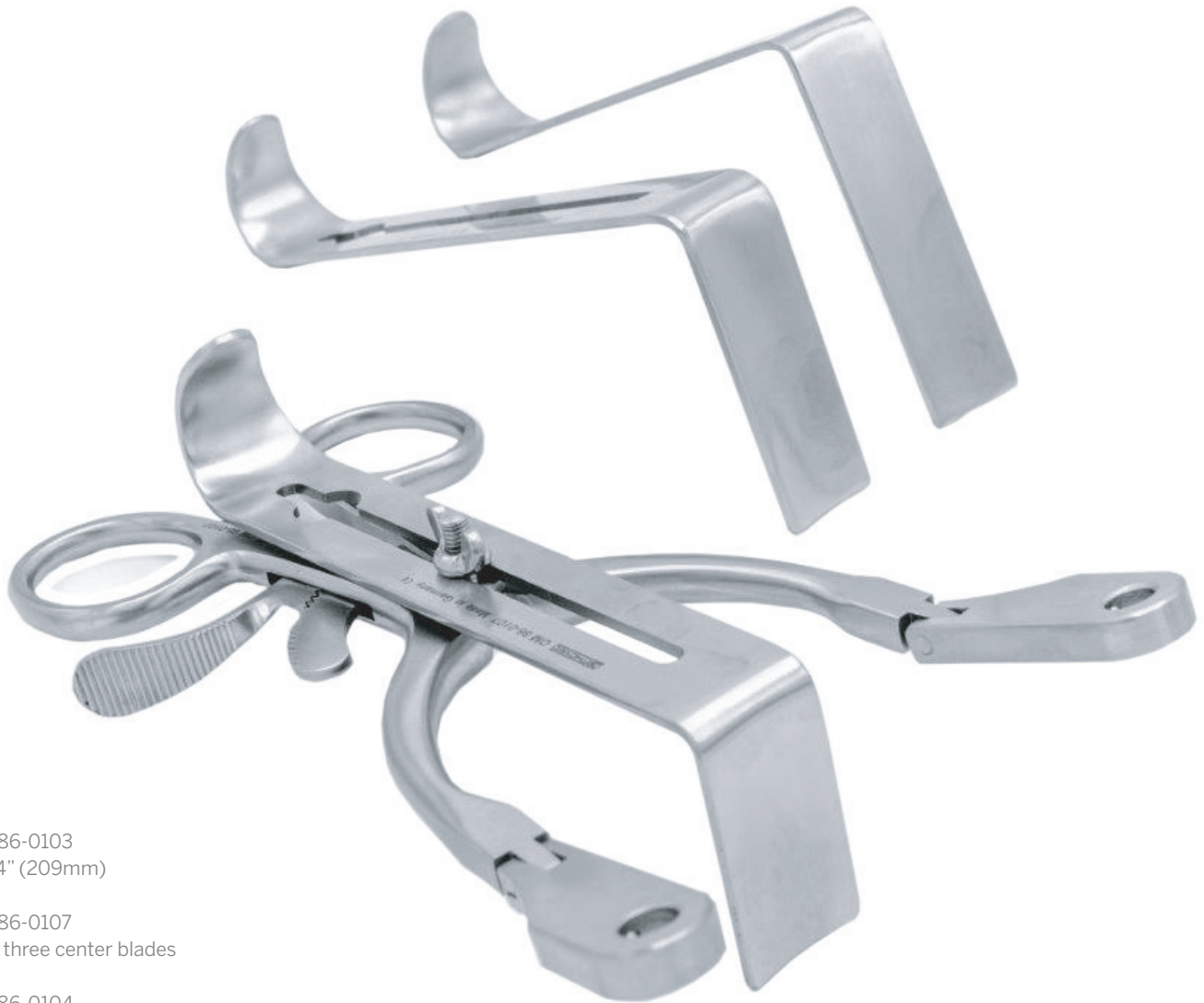

OM 86-0103
8 1/4" (209mm)

OM 86-0107
with three center blades

OM 86-0104
Retractor only (to be used with center blades)

OM 86-0106
Center blade 36mm x 20mm

OM 86-0108
Center blade 53mm x 20mm

OM 86-0109
Center blade 68mm x 20mm

KOLBEL RETRACTOR
with one center blade



OM 46-0874
9" (229mm)
11mm wide blade

**SINGLE POINT
GLENOID RETRACTOR**



OM 46-0875
10" (254mm)
25mm wide blade

**HUMERAL HEAD
RETRACTOR**



These two retractors sit in the glenoid neck and retract medially the subscapularis. Also, during instability repairs they assist in tacking down the medial flap of the incised capsule.

OM 86-0040
15mm
wide blade

OM 86-0045
20mm
wide blade

GLENOID LEVER



OM 46-0922
7" (179mm)
2 X 2 prong angled

KOLBEL SUBSCAPULARIS RETRACTOR



OM 86-0090
no blades included

KOLBEL SHOULDER RETRACTOR

Square frame only

The single prong Retractor is commonly used when retracting on the interior rim of the glenoid.

OM 86-0100
10" (254mm)
20mm wide



CAPSULE RETRACTOR

One prong

Designed to be placed medially along the scapular neck to retract the anterior capsule and labrium.

OM 86-0105
10" (254mm)
20mm wide



CAPSULE RETRACTOR

Two prong

Designed to be placed medially along the scapular neck to retract the anterior capsule and labrium.

OM 86-0110
10" (254mm)
20mm wide



CAPSULE RETRACTOR

Three prong

OM 46-0860
8 3/4" (222mm)
18mm blade width

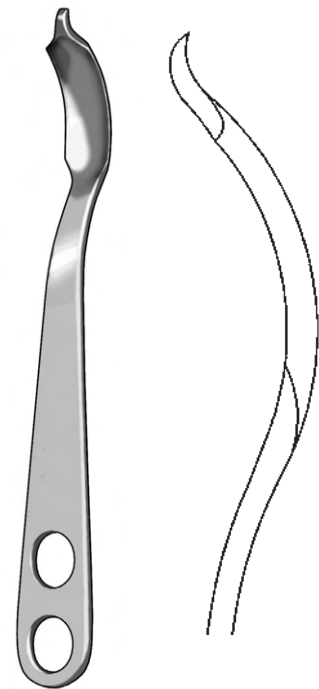

HUMERAL HEAD RETRACTOR

OM 48-0201
10 3/4" (273mm)
24mm blade width

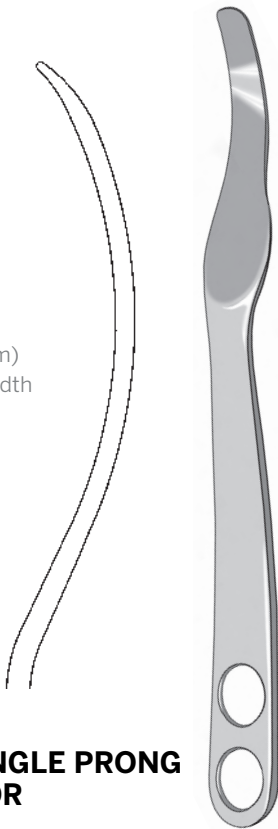

PELVIC SINGLE PRONG RETRACTOR

OM 48-0204
10 1/2" (267mm)
44mm blade width



BLOUNT DOUBLE PRONG RETRACTOR

OM 48-0202
10 1/2" (267mm)
37mm blade width



BLOUNT SINGLE PRONG RETRACTOR

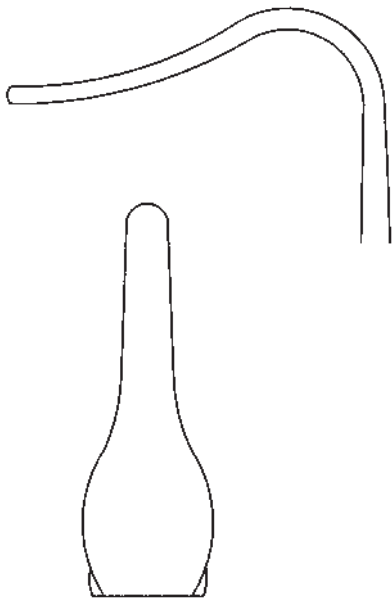

OM 48-0206
7" (178mm)
6mm width distal tip

BLOUNT KNEE RETRACTOR



OM 48-0180
57mm blades, 69mm deep, 11mm wide

OM 48-0184
63mm blades, 76mm deep, 11mm wide

DOANE KNEE RETRACTOR
6" (152mm) a.k.a. "Z" Retractor



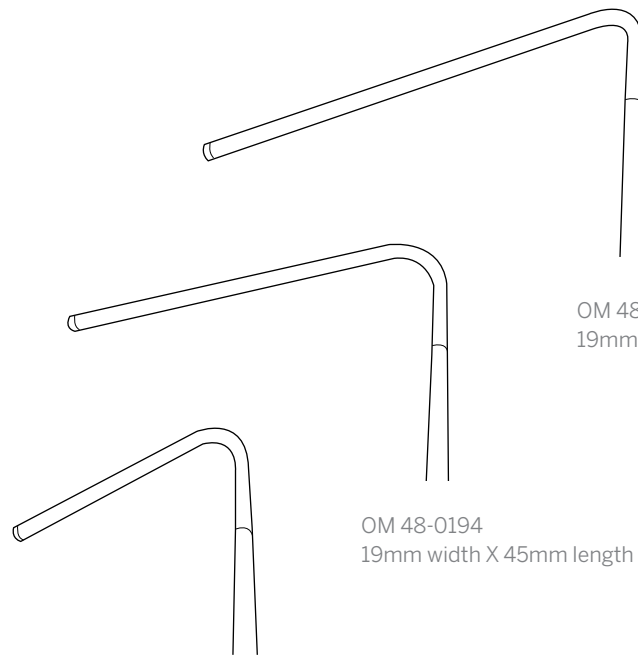
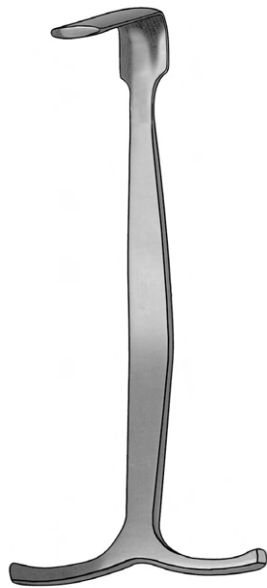

OM 48-0196
19mm width X 60mm length blade

OM 48-0194
19mm width X 45mm length blade

OM 48-0198
19mm width X 30mm length blade

SMILLIE KNEE RETRACTOR

5 1/2" (140mm)

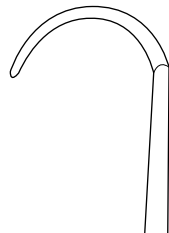
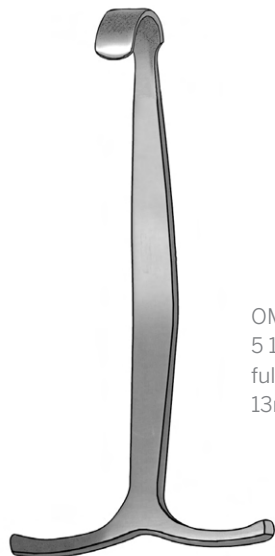

OM 48-0200
5 1/2" (140mm)
full curve
13mm width X 18mm length blade

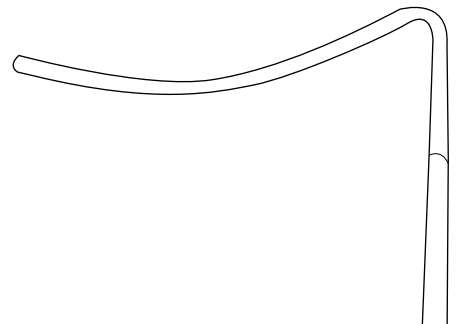
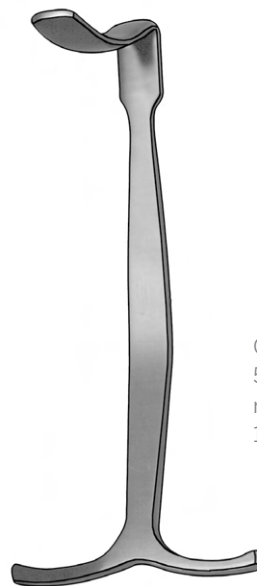

OM 48-0192
5 1/2" (140mm)
reverse curve
13mm width X 55mm length blade

SMILLIE KNEE RETRACTOR

SMILLIE KNEE RETRACTOR

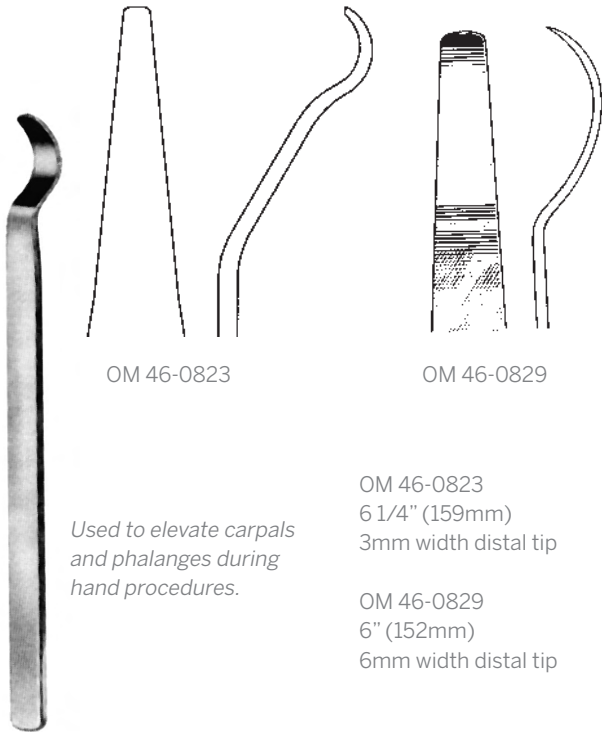

OM 46-0823

OM 46-0829

Used to elevate carpals and phalanges during hand procedures.

OM 46-0823
6 1/4" (159mm)
3mm width distal tip

OM 46-0829
6" (152mm)
6mm width distal tip

HAYES HAND RETRACTOR

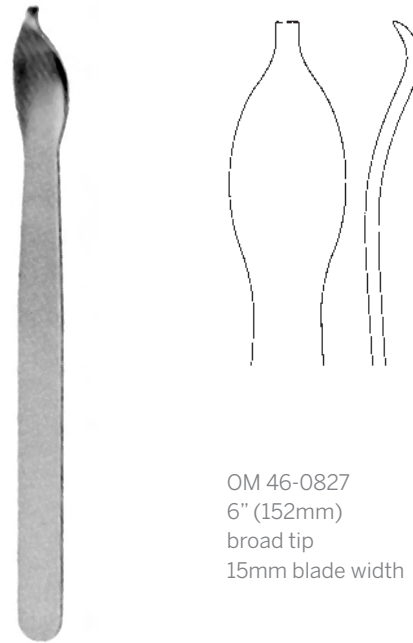

OM 46-0827
6" (152mm)
broad tip
15mm blade width

HOHMANN RETRACTOR

For small fragments.

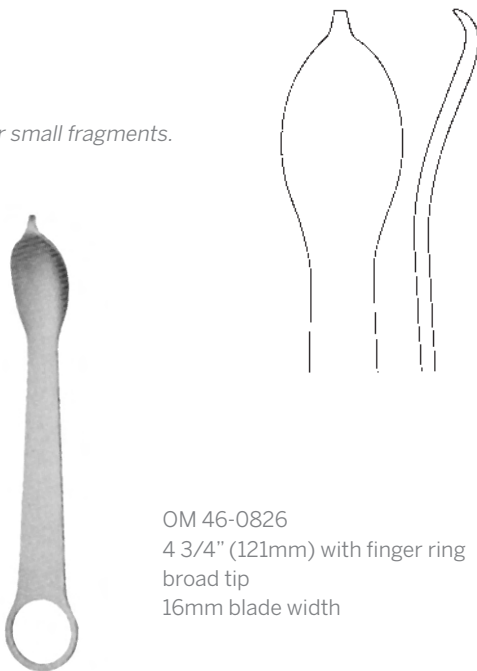

OM 46-0826
4 3/4" (121mm) with finger ring
broad tip
16mm blade width

HOHMANN RETRACTOR

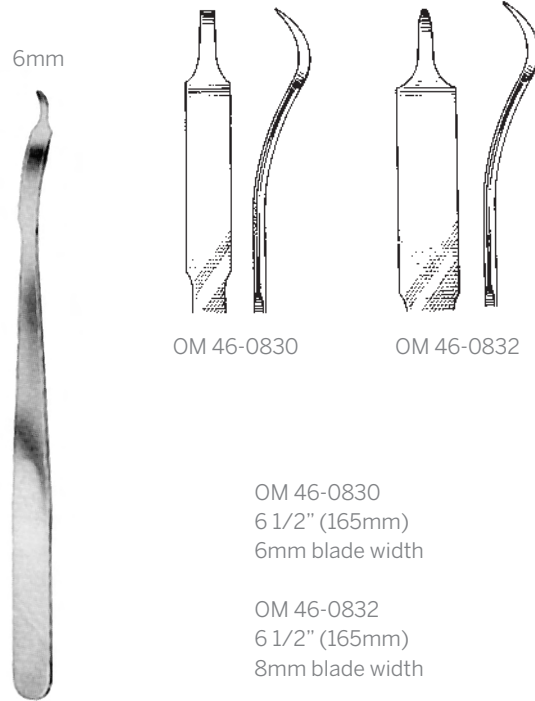

OM 46-0830

OM 46-0832

OM 46-0830
6 1/2" (165mm)
6mm blade width

OM 46-0832
6 1/2" (165mm)
8mm blade width

MINI HOHMANN RETRACTOR

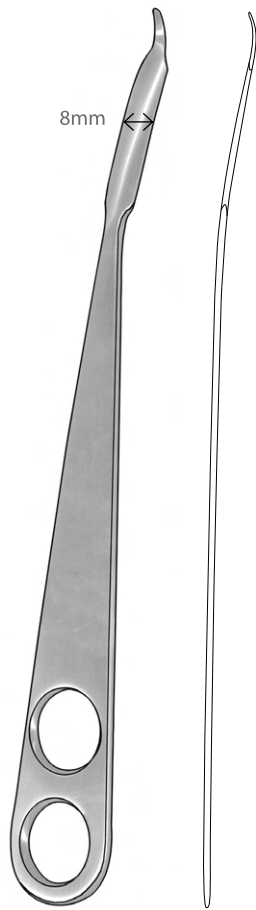

OM 46-0858
8 1/2" (216mm)
8mm blade width

OM 46-0836
9" (229mm)
10mm blade width

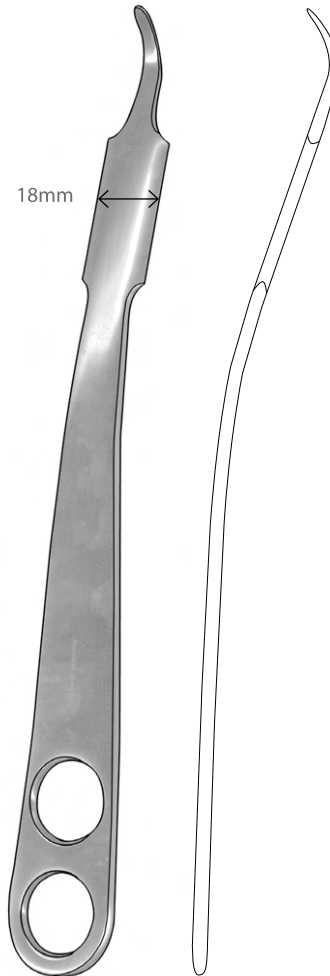

OM 46-0838
9" (229mm)
18mm blade width

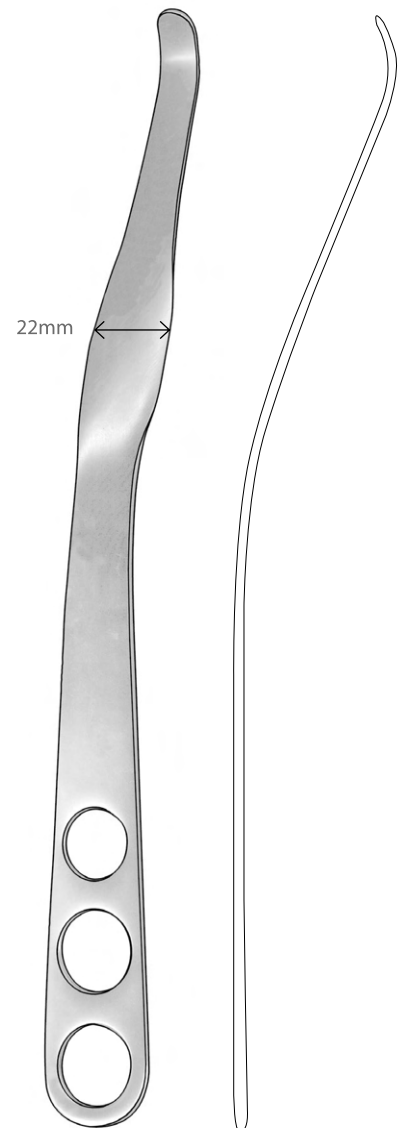

OM 46-0848
11" (279mm)
22mm blade width
3 holes

HOHMANN RETRACTOR

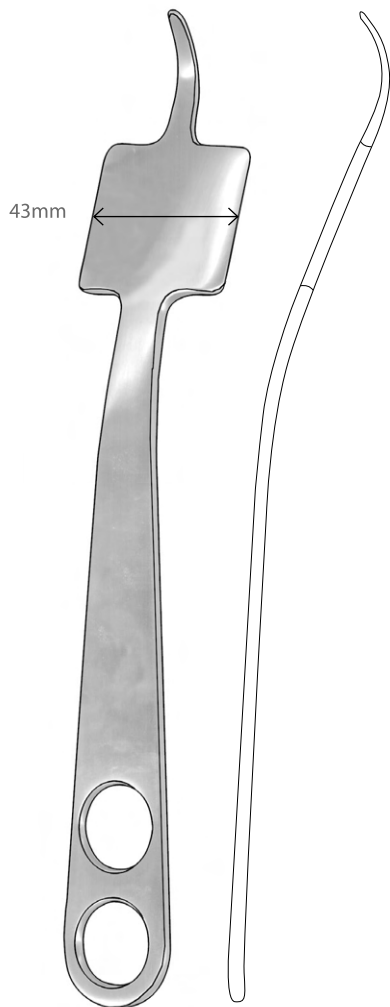

OM 46-0842
9 1/2" (241mm)
43mm blade width

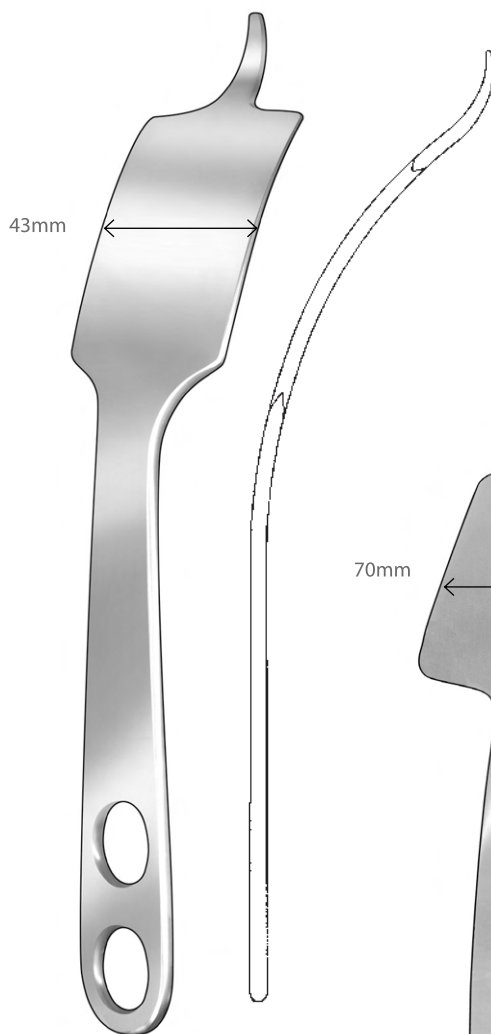

OM 46-0841
9" (228mm)
43mm blade width
long 64mm shank

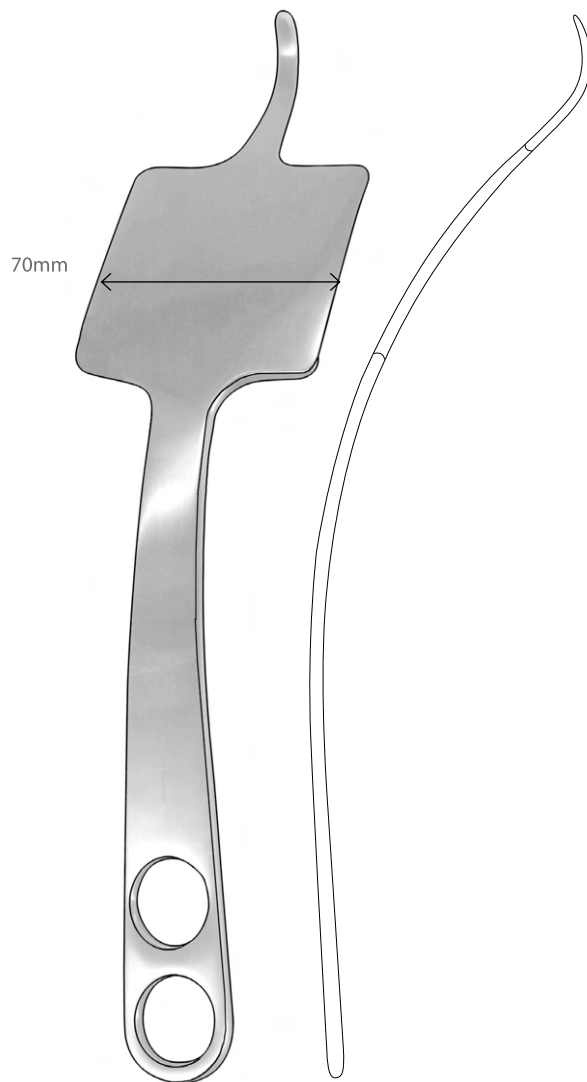

OM 46-0850
9 1/2" (241mm)
70mm blade width

HOHMANN RETRACTORS

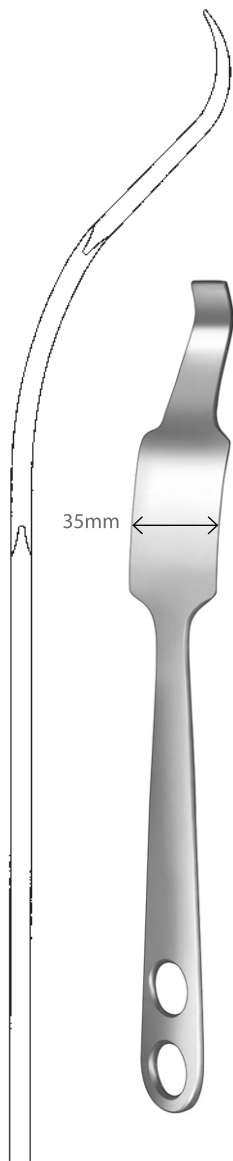

35mm

OM 46-0849
11 1/4" (286mm)
35mm blade width
with wide tip
long 52mm shank

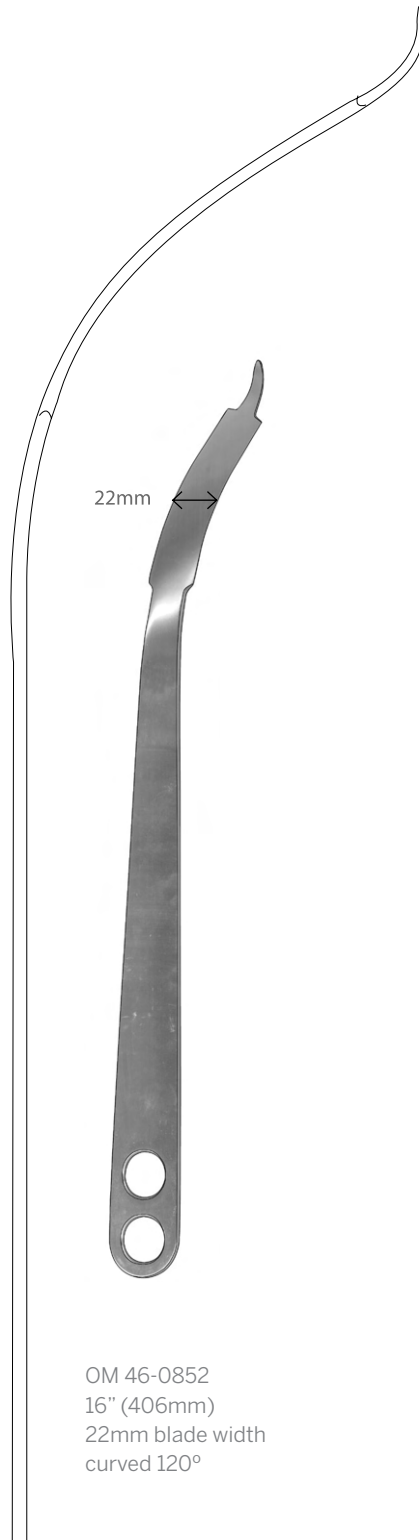

22mm

OM 46-0852
16" (406mm)
22mm blade width
curved 120°

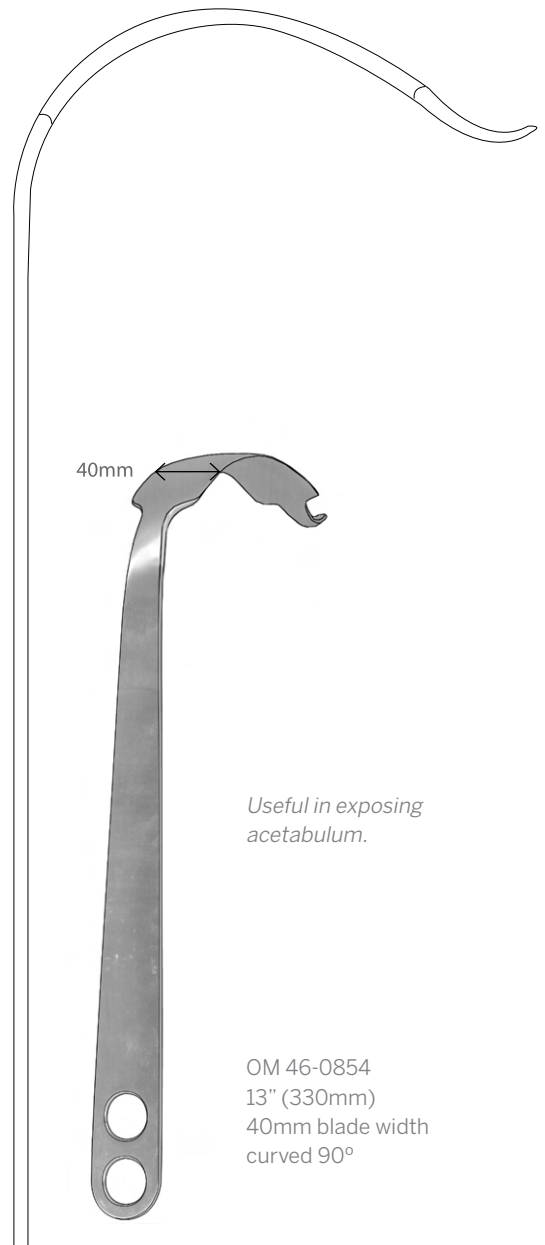

40mm

*Useful in exposing
acetabulum.*

OM 46-0854
13" (330mm)
40mm blade width
curved 90°

HOHMANN RETRACTOR



OM 90-6210-02
12 1/2" (318mm)
15mm blade width

**DOUBLE BENT HOHMAN
RETRACTOR**



OM 46-0840
10" (254mm)
15mm blade width

HOHMAN RETRACTOR



OM 82-0033
8" (203mm)
8mm blade width

BODNER RETRACTOR NARROW



OM DP29995860
11 1/2" (295mm)

**MOTHER-IN-LAW
RETRACTOR**



OM 46-0851
11 1/2" (295mm)
23mm blade width

HOHMAN RETRACTOR



OM 46-0838S
9" (229mm)
18mm blade width square tip

HOHMAN RETRACTOR



OM 46-0868
90 degree bend 10mm blade width

**RIGHT ANGLED
HOHMANN RETRACTOR**



OM 90-7110
11" (280mm) right angle
18mm blade width

BENT HOHMANN



OM 86-0120L
12 1/2" (318mm) right angle
18mm blade width

**RIGHT ANGLE HOHMANN
RETRACTOR LONG**



OM 46-0855
11" (280mm) right angle
22mm blade round tip

**RIGHT ANGLED
HOHMANN
RETRACTOR**



OM 90-6630
8" (208mm)
21mm blade width

**COLLATERAL
LIGAMENT RETRACTOR
LONG PRONG**



OM 86-0115L
10 1/4"
43mm blade width

**RIGHT ANGLED
HOHMANN
RETRACTOR LONG**



OM DP2581-00
11"

**BLOUNT
RETRACTOR
DOUBLE PRONG**



OM 90-6570
12" (305mm)
22mm blade width

**SINGLE PRONG
ACETABULAR RETRACTOR**



OM D869054
10" (254mm)
22mm blade width

**MK COLLATERAL
LIGAMENT RETRACTOR**



OM D259807190
10" (254mm)
22mm blade width

**NARROW CURVED
HOHMANN**



OM 86-0172
11" (280mm)
7 1/2" (191mm) blade length
2" (50mm) blade width

NERVE RETRACTOR SHORT

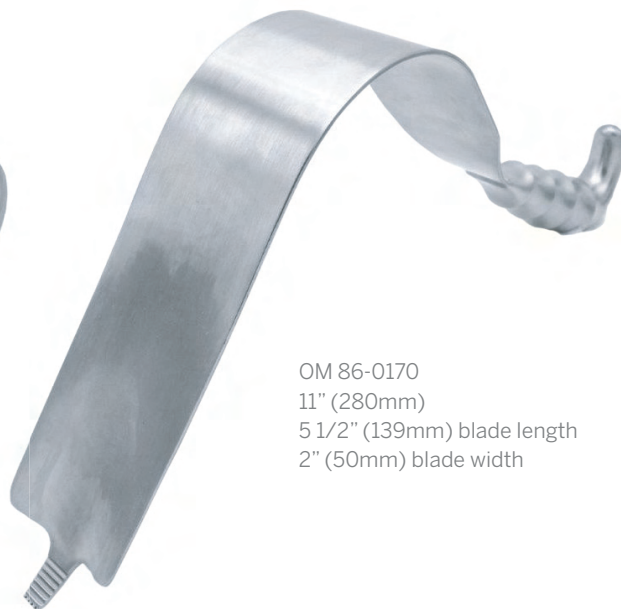

OM 86-0170
11" (280mm)
5 1/2" (139mm) blade length
2" (50mm) blade width

NERVE RETRACTOR LONG



OM SP-1066
8" (203mm)
1 1/4" width X 5" blade length

TAYLOR RETRACTOR LONG BLADE

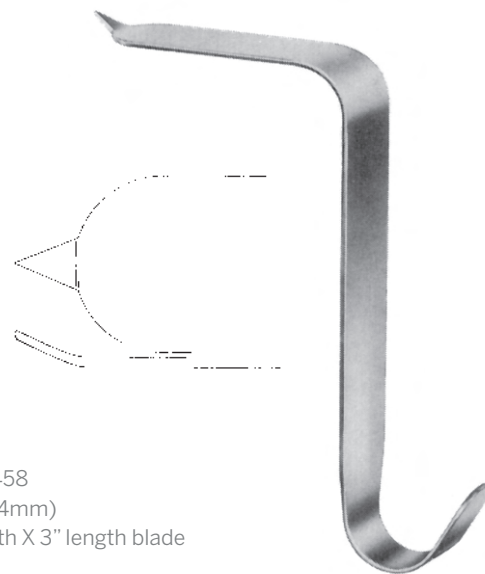

OM 52-0458
7 1/4" (184mm)
1 1/4" width X 3" length blade

OM 52-0460
8" (203mm)
1 1/4" width X 4" length blade

TAYLOR SPINAL RETRACTOR



OM 90-3410

FEMORAL NECK RETRACTOR 13"

The hook at the end of the retractor engages the radius as the wing retracts the pronator, but the wing does not contact the median nerve. The section above the wing which contacts the median nerve has been narrowed to avoid excessive pressure, and possible damage to the nerve.

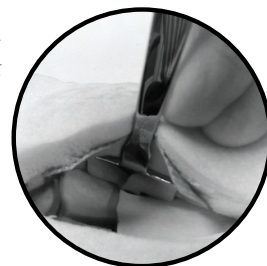

OM 91-0500
6 3/8" (164mm) Overall length
1 1/16" (27mm) Wing width

CARLSON PRONATOR RETRACTOR 2MM



Right angled Hohmann's are useful in both knee and hip arthroplasty for retracting tissue at the margins of the joint. It is placed over the margins of the joint to achieve maximum exposure.

The "C" retractor is designed to retract the femur anteriorly during total hip arthroplasty. Placement is made over the pelvic brim for best exposure.

Wide blade designed for retracting around the hip. Very useful for retracting tissue in the posterior acetabular brim.

OM 86-0125
14" (356mm)
22mm wide blade

"C" RETRACTOR



Narrow blade usually designed for retracting around the knee.

OM 86-0120
9 3/4" long
18mm wide blade

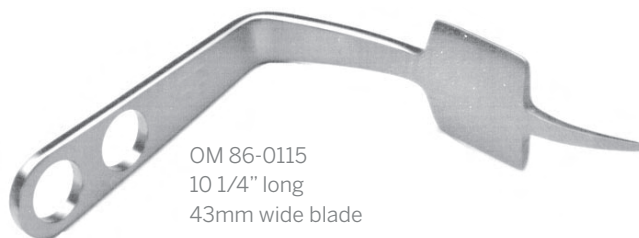

OM 86-0115
10 1/4" long
43mm wide blade

RIGHT ANGLED HOHMANN RETRACTOR

Designed to retract and give exposure to the iliac crest for graft harvesting.

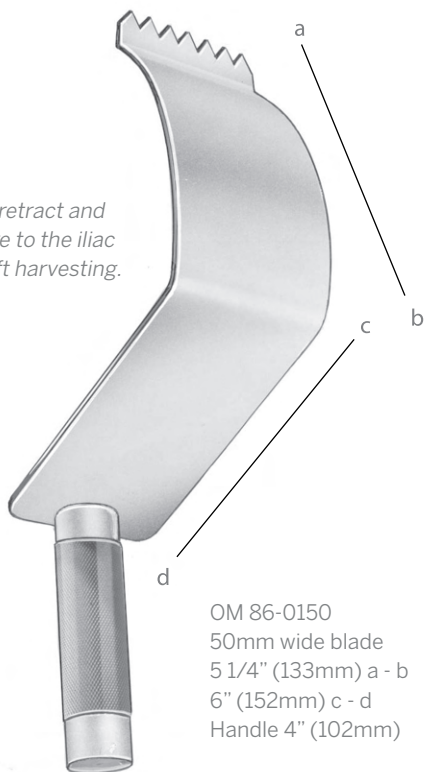

OM 86-0150
50mm wide blade
5 1/4" (133mm) a - b
6" (152mm) c - d
Handle 4" (102mm)

WAUGH RETRACTOR

For spine



OM 86-0155
15" (38mm)

ACETABULAR RETRACTOR

Note: The new Vickers retractors are designed to provide excellent visibility during hand and wrist procedures. Each of the retractors are self-retaining and automatically expand the wound site.

Ideal for retracting wounds on either the front, back or sides of fingers or thumb.



OM 52-0425
2" X 3/4" X 1 1/4"
(51mm X 19mm X 32mm)
2 X 2 blunt hooks
maximum opening: 3/4"

HAYES HAND RETRACTOR

Note: Useful for trigger finger and small wound retraction. The curved smooth blades hold fat tissue away from tendon sheath.

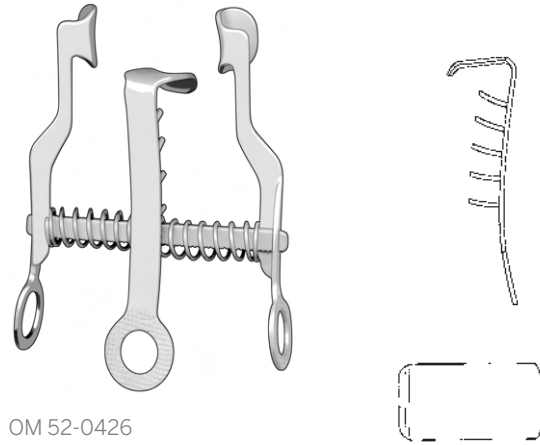

OM 52-0426
2 1/2" X 3" (64mm X 76mm)
10mm depth X 12mm height
curved smooth blades
maximum opening: 30mm
center blade: 10mm X 16mm

Center blade for low profile retractors.

VICKERS LOW PROFILE SMALL WOUND RETRACT

Ideal for tendon transfers with three blunt prongs to secure placement.

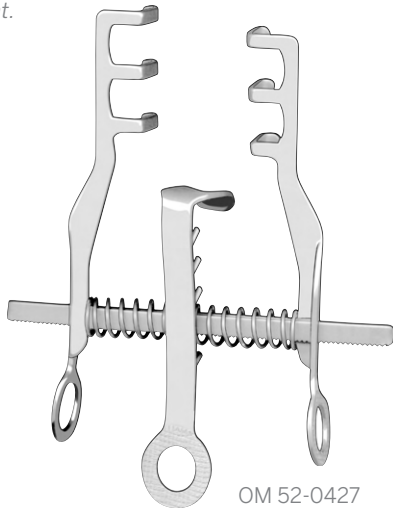

OM 52-0427
3" X 3 3/4" (76mm X 95mm)
3 X 3 blunt prongs
11mm depth X 25mm height
maximum opening: 35mm
center blade: 10mm X 16mm

VICKERS LOW PROFILE HAND AND FOREARM RETRACTOR

Useful for hand and carpal tunnel procedures with two blunt prongs to secure placement.

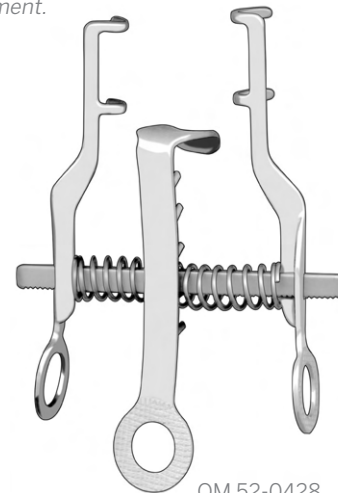

OM 52-0428
2 1/2" X 3" (64mm X 76mm)
2 X 2 blunt prongs
8mm depth X 17mm height
maximum opening: 30mm
center blade: 10mm X 16mm

VICKERS LOW PROFILE UNIVERSAL RETRACTOR

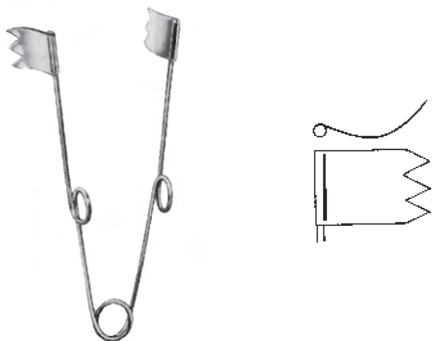

OM 52-0420
 3 1/4" (83mm) very delicate
 3 X 3 teeth
 10mm width X 13mm height blades

SPRING WIRE RETRACTOR

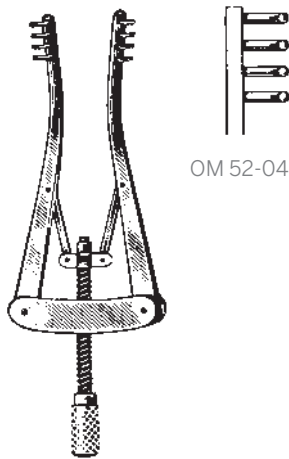

OM 52-0416

OM 52-0414
 2 3/4" (70mm) delicate
 4mm depth X 8mm height

OM 52-0416
 4" (102mm) delicate
 5mm depth X 9mm height

ALM RETRACTOR

4 blunt prongs



OM 52-0418

OM 52-0417
 4" (102mm) delicate
 4 sharp prongs
 3mm depth X 8mm height

OM 52-0418
 4" (102mm) delicate
 4 blunt prongs
 3mm depth X 8mm height

**SELF-RETAINING RETRACTOR
 (HEISS)**



OM 52-0422
 4" (102mm)
 3 X 3 blunt prongs

OM 47-0423-0422
 4" (102mm)
 3 X 3 sharp prongs

JANSEN RETRACTOR

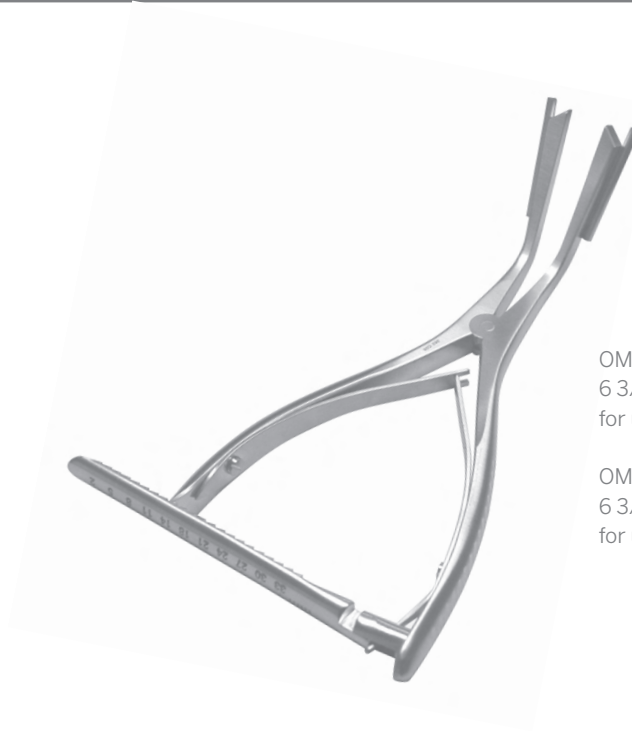

OM 48-0223
6 3/4 " (171mm)
for up to .062" (1.6mm)

OM 48-0224
6 3/4 " (171mm)
for up to 7/64" (2.8mm)

JOINT AND CALCANEAL SPREADER



Two hole design allows for .062" (1.6mm) and 3/32" (2.4mm) wire.

OM 90-4210-SS Distractor 6" (152mm)
OM 90-4210-SB Distractor 6" (152mm) bent

JOINT CALCANEAL (Hintermann)

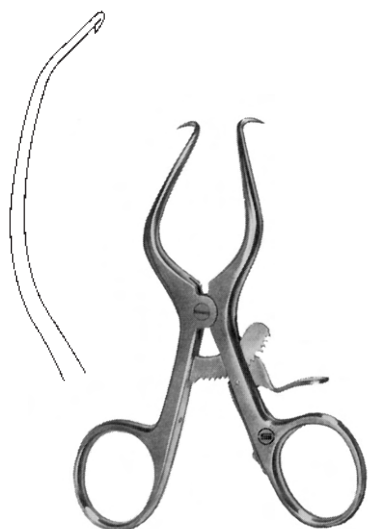

OM 52-0778

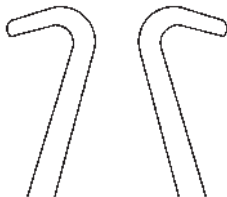

OM 52-0770

Sharp Points

OM 52-0776 3 1/2" (89mm)
 OM 52-0778 4 1/2" (114mm)
 OM 52-0780 5 1/2" (140mm)
 OM 52-0768 7 1/2" (191mm)

Blunt Points

OM 52-0770 7 1/2" (191mm)

GELPI RETRACTOR

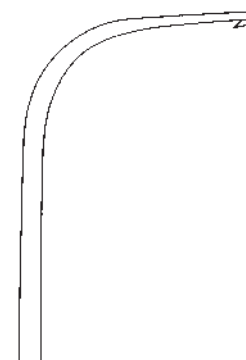

OM 52-0765
 6 1/4" (159mm)
 sharp points
 deep blades

OM 52-0766
 6 1/4" (159mm)
 blunt

GELPI-SELETZ RETRACTOR

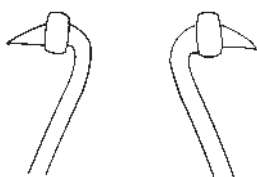

OM 52-0769
 7" (178mm)
 with ball stops
 sharp points

GELPI RETRACTOR

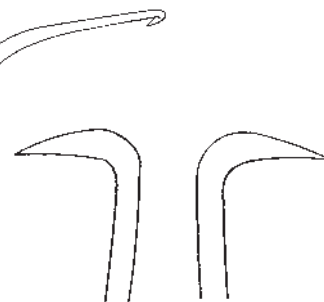
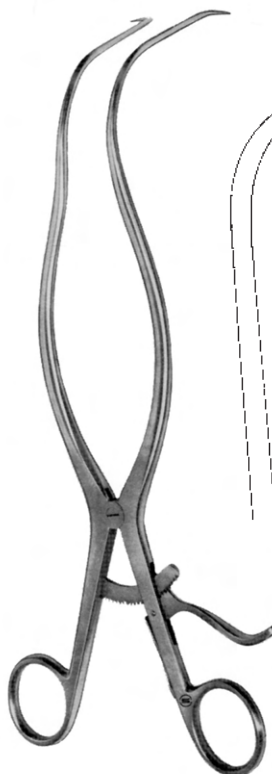

OM 52-0771
 11" (279mm)
 deep blades
 sharp points

WILTSE-GELPI RETRACTOR



OM 55-0497
 4 1/4" (108mm)
 3 X 3 sharp prongs
 10mm depth x 14mm height

SNITMAN ENDAURAL RETRACTOR

Handle conforms to contour of skull. Also useful in hand and foot procedures because handle is not obstructive.

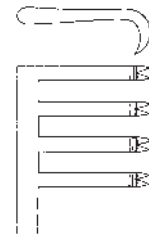

OM 52-0548
 5 1/2" (140mm)
 3 X 4 sharp prongs
 15mm depth X 20mm height

OM 52-0546
 5 1/2" (140mm)
 3 X 4 blunt prongs
 15mm depth X 20mm height

VICKERS LOW PROFILE SMALL WOUND RETRACTOR

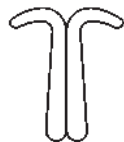
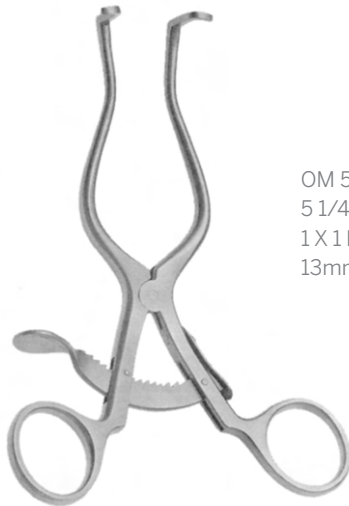

OM 55-0438
 5 1/4" (133mm)
 1 X 1 blunt prongs
 13mm depth

TISSUE RETRACTOR

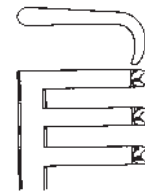
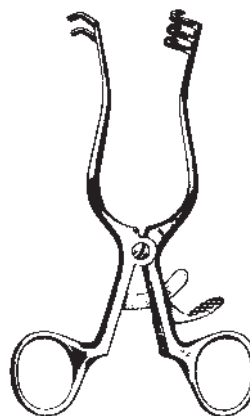

OM 52-0492

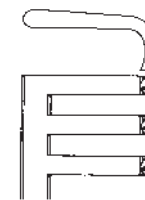

OM 52-0494

OM 52-0492
 4" (102mm) sharp
 2 X 3 prongs
 13mm depth X 13mm height

OM 52-0494
 4" (102mm) blunt
 2 X 3 prongs
 13mm depth X 13mm height

WEITLANER RETRACTOR

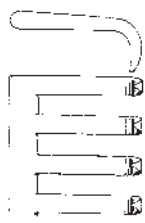
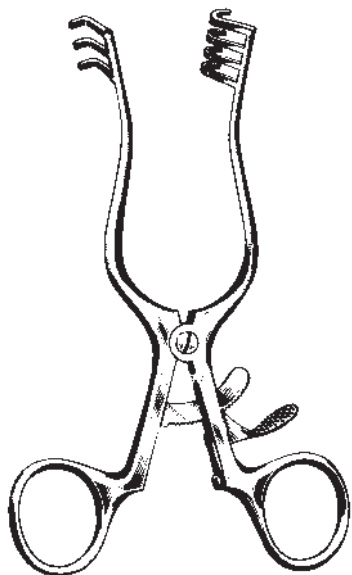

OM 52-0498

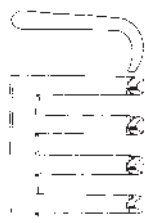

OM 52-0518



OM 52-0506



OM 52-0526

3 X 4 sharp prongs

OM 52-0498	5 1/2" (140mm)	14mm depth X 18mm height
OM 52-0502	6 1/2" (165mm)	15mm depth X 20mm height
OM 52-0504	8" (203mm)	16mm depth X 20mm height
OM 52-0506	9 1/2" (241mm)	23mm depth X 21mm height

3 X 4 blunt prongs

OM 52-0518	5 1/2" (140mm)	14mm depth X 18mm height
OM 52-0522	6 1/2" (165mm)	15mm depth X 20mm height
OM 52-0524	8" (203mm)	16mm depth X 20mm height
OM 52-0526	9 1/2" (241mm)	23mm depth X 21mm height

WEITLANER RETRACTOR

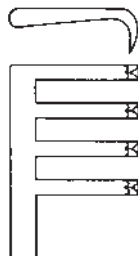
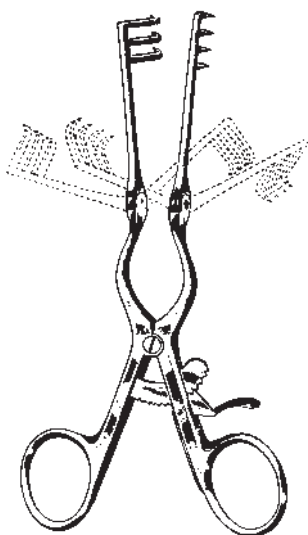

OM 52-0532



OM 52-0538

3 X 4 sharp prongs

OM 52-0530	5 1/2" (140mm)	15mm depth X 20mm height
OM 52-0532	6 1/2" (165mm)	15mm depth X 20mm height
OM 52-0534	8 1/2" (216mm)	17mm depth X 22mm height
OM 52-0542	9 1/2" (241mm)	24mm depth X 22mm height

3 X 4 blunt prongs

OM 52-0536	5 1/2" (140mm)	15mm depth X 20mm height
OM 52-0538	6 1/2" (165mm)	15mm depth X 20mm height
OM 52-0540	8 1/2" (216mm)	17mm depth X 22mm height
OM 52-0544	9 1/2" (241mm)	24mm depth X 22mm height

BECKMAN-WEITLANER RETRACTOR

Hinged blades



OM 52-0442
 7 1/2" (191mm) straight
 4 X 4 sharp prongs
 18mm depth X 18mm height



OM 52-0444
 7 1/2" (191mm) angled
 4 X 4 sharp prongs
 18mm depth X 18mm height

ADSON RETRACTOR

Note:

- Ratchet is calibrated in millimeters to accurately assess how wide the lateral portion of the bone graft needs to be.
- Helpful in many types of procedures to accurately assess the amount of bone graft needed, such as for fusions and nonunions.

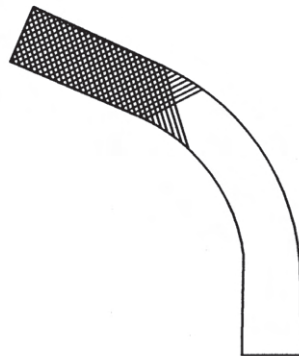
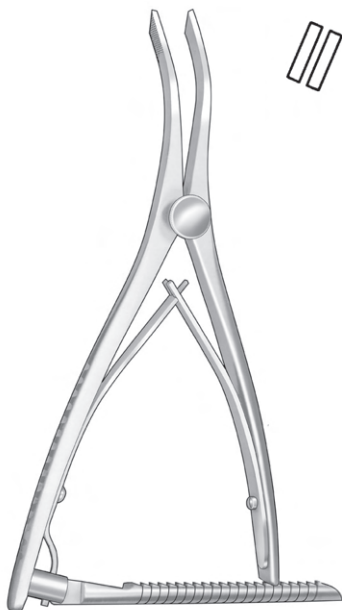

OM 48-0220
 6 1/2" (165mm)
 35mm calibrated ratchet

OM 48-0221
 10" (254mm)
 70mm calibrated ratchet



**SAXENA BONE GRAFTING
 RETRACTOR**

Angular prongs are heavier than those on a standard Adson.

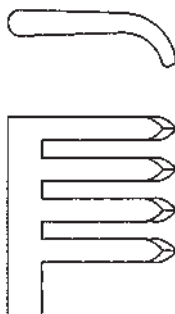
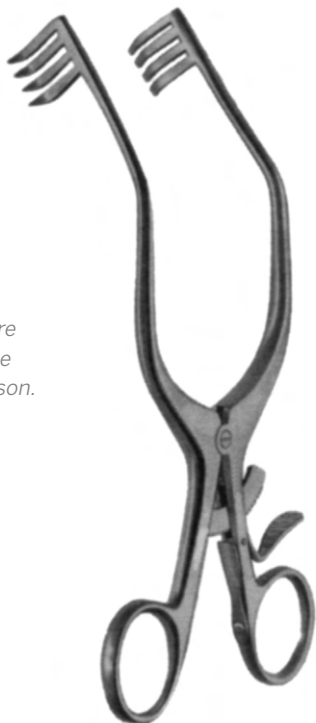

OM 55-0498
7 3/8" (187mm)
4 X 4 sharp prongs
22mm depth X 19mm height

D'ERRICO-ADSON RETRACTOR

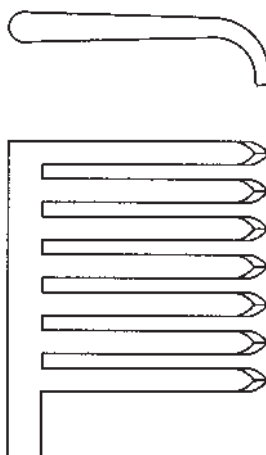

OM 55-0499
7 1/2" (191mm)
7 X 7 sharp prongs
35mm depth X 32mm height

OM 55-0500
7 1/2" (191mm)
7 X 7 blunt prongs
35mm depth X 32mm height

MISKIMON CEREBELLUM RETRACTOR

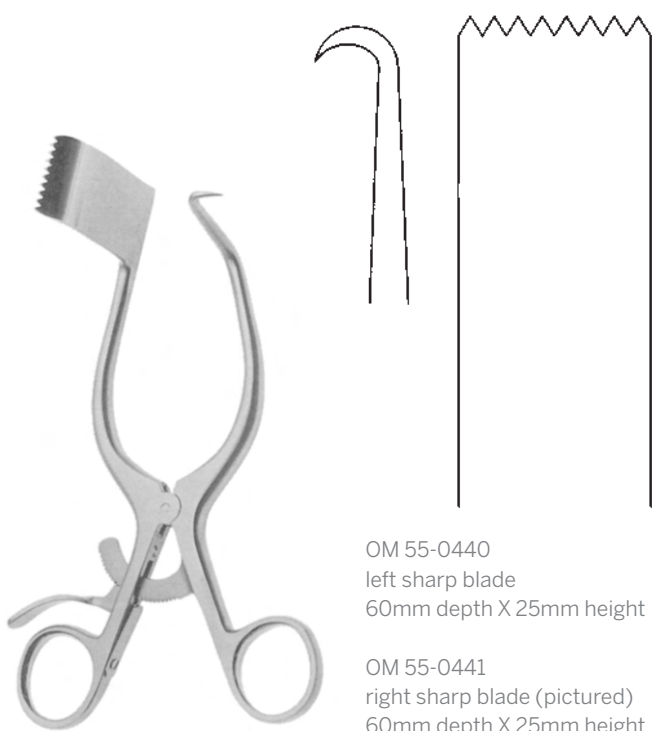

OM 55-0440
left sharp blade
60mm depth X 25mm height

OM 55-0441
right sharp blade (pictured)
60mm depth X 25mm height

**MARKHAM-MEYERDING
HEMILAMINECTOMY RETRACTOR**
7" (178mm)

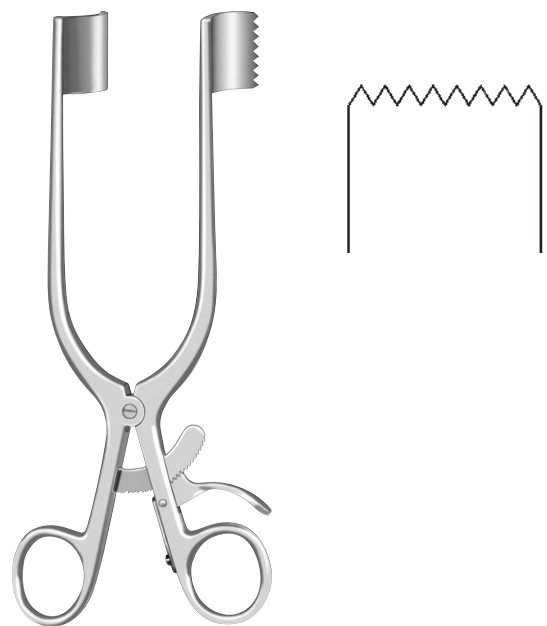

Sharp blades
OM 55-0430 57mm depth X 25mm height
OM 55-0431 51mm depth X 25mm height
OM 55-0432 41mm depth X 25mm height

MEYERDING LAMINECTOMY RETRACTOR
6 1/2" (165mm)



Left
OM 52-0554 50mm X 20mm blade
OM 52-0556 60mm X 20mm blade
OM 52-0558 70mm X 20mm blade
OM 52-0560 80mm X 20mm blade
OM 52-0562 90mm X 20mm blade
OM 52-0564 100mm X 20mm blade
OM 52-0566 110mm X 20mm blade

Right
OM 52-0574 50mm X 20mm blade
OM 52-0576 60mm X 20mm blade
OM 52-0578 70mm X 20mm blade
OM 52-0580 80mm X 20mm blade
OM 52-0582 90mm X 20mm blade
OM 52-0584 100mm X 20mm blade
OM 52-0586 110mm X 20mm blade

WILLIAMS HEMILAMINECTOMY RETRACTOR

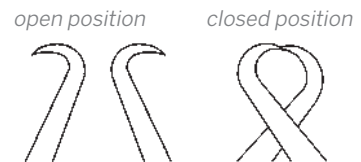

Designed to aid in the removal of interdigital neuroma.

Tips overlap in closed position making insertion and removal of retractor easier.

Provides excellent visibility of neuroma when retractor is in open position.

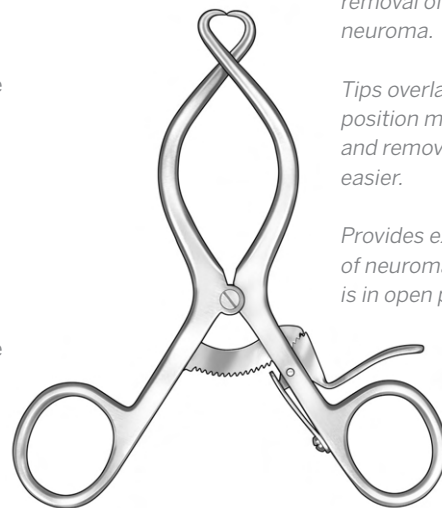

OM 52-0782 5 1/2" (140mm) sharp
JOHNSON NEUROMA RETRACTOR

Note:

Deeper blades available upon special order.

Used primarily for hip procedures.



OM 52-0704
4 sharp prongs
stainless steel
maximum retraction width:
9 3/4" (247mm)
prong depth: 1" (25mm)
blade width: 1" (25mm)
weight: 3 lbs.

OM 52-0704W
Weight and chain only

OM 52-0704F
Frame only

Other blades available:
Prongs Depth X Blade Width
1 1/2" x 1" (25mm x 38mm)
1" x 1 3/4" (25mm x 38mm)
1" x 1" (25mm X 25mm)
2" x 1" (51mm X 25mm)
2 1/4" x 1" (57mm X 25mm)
2 1/2" x 1" (64mm X 25mm)
3" x 1" (76mm X 25mm)
4" x 1" (102mm X 25mm)
5" x 1" (127mm X 25mm)

Short Blade
OM 52-0703S

OM 52-0704S
OM 52-0705S
OM 52-0706S
OM 52-0707S
OM 52-0708S
OM 52-0709S
OM 52-0711S

Long Blade

OM 52-0703L
OM 52-0704L
OM 52-0705L
OM 52-0706L
OM 52-0707L
OM 52-0708L
OM 52-0709L
OM 52-0711L

INITIAL INCISION RETRACTOR



Prongs Depth X Blade Width
2" X 1" (51mm X 25mm)
2 1/2" X 1" (64mm X 25mm)
4" X 1" (102mm X 25mm)
5" X 1" (127mm X 25mm)

Short Blade
OM 52-0705SR
OM 52-0707SR
OM 52-0709SR
OM 52-0711SR

SHORT ROUND BLADES AVAILABLE

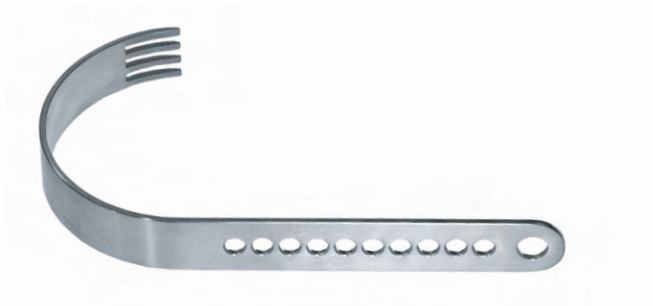

Prongs Depth X Blade Width Long Blade
2 1/4" X 1" (57mm X 25mm) OM 52-0706LR
3" X 1" (76mm X 25mm) OM 52-0708LR
4" X 1" (102mm X 25mm) OM 52-0709LR

LARGE ROUND BLADES AVAILABLE

Note:

For OM 48-0217, originally designed as a Lamina Spreader. Also very useful in hand, foot and knee procedures. Available with or without teeth.



VERTEBRAL BODY DISTRACTOR

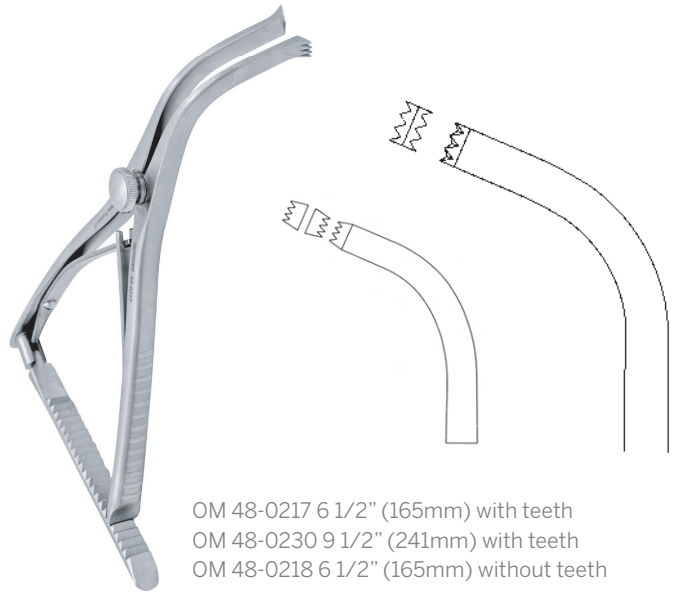

ADSON RETRACTOR

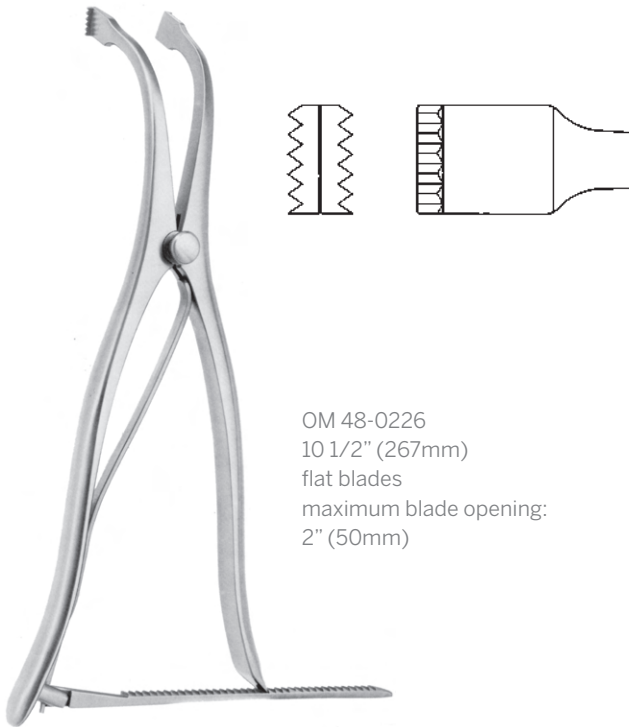

LAMINA SPREADER

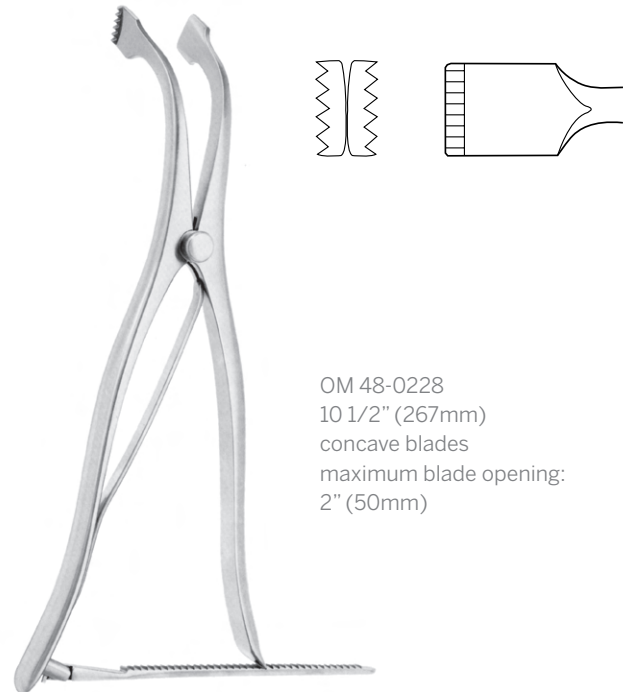

LAMINA SPREADER

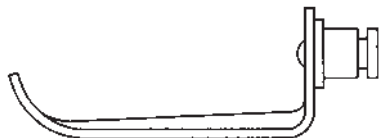
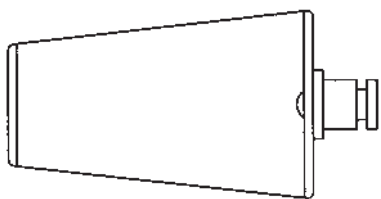

Set includes:

- OM 55-0481 Cervical retractor body, small, 6" (152mm)
- OM 55-0482 25mm blade depth
- OM 55-0483 30mm blade depth
- OM 55-0484 35mm blade depth
- OM 55-0485 40mm blade depth
- OM 55-0486 45mm blade depth
- OM 55-0487 50mm blade depth
- OM 55-0488 55mm blade depth

OM 55-0480
7 pairs of blunt blades and body

CERVICAL RETRACTOR SET



OM 55-0492

CERVICAL LAMINA SPREADER

3 3/4" Deep 3mm Tip



OM 55-0490 #1 with ratchet
5" (127mm)
spread: 3/4" (19mm)

VERTEBRA SPREADER

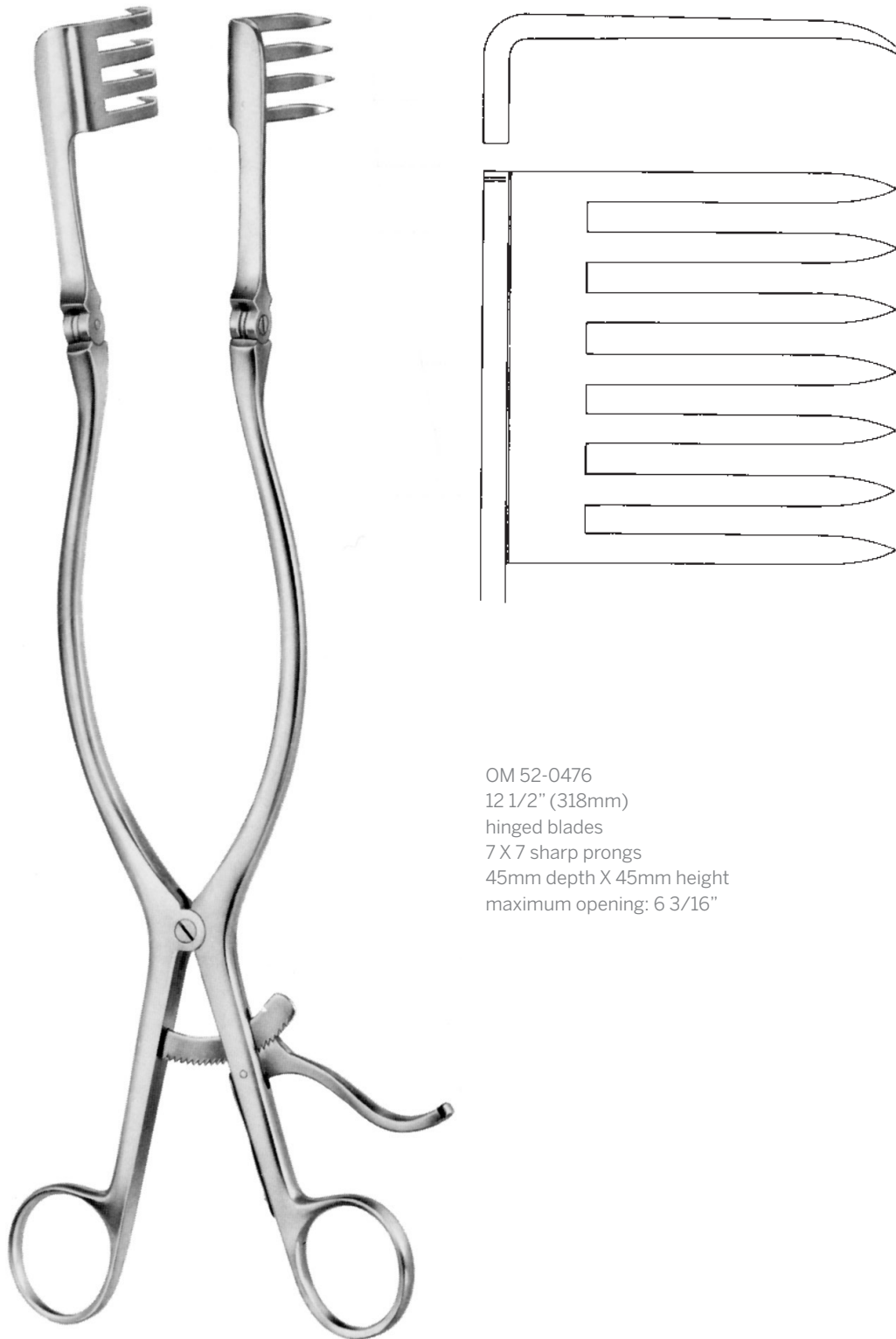

OM 52-0476
12 1/2" (318mm)
hinged blades
7 X 7 sharp prongs
45mm depth X 45mm height
maximum opening: 6 3/16"

BECKMAN-EATON RETRACTOR

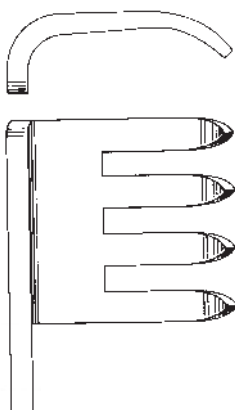
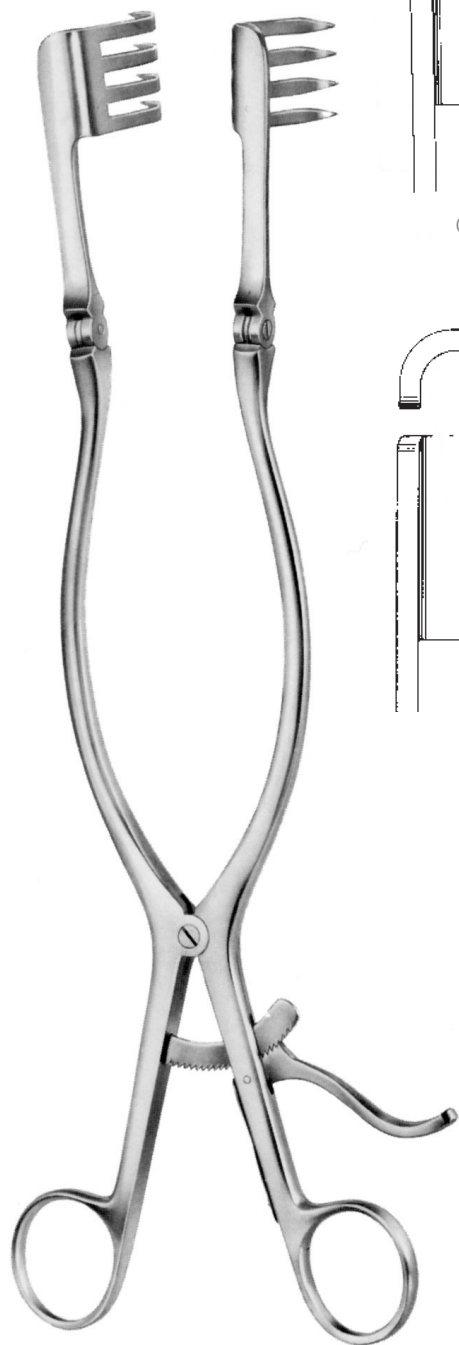

OM 52-0490

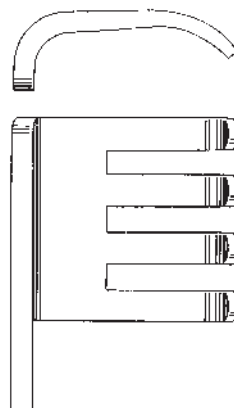

OM 52-0484

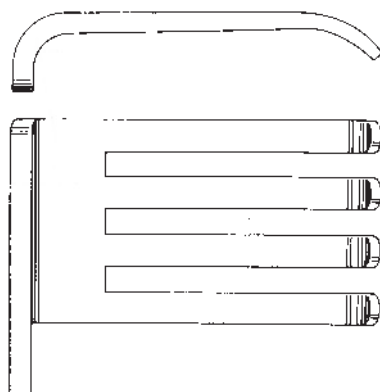

OM 52-0488

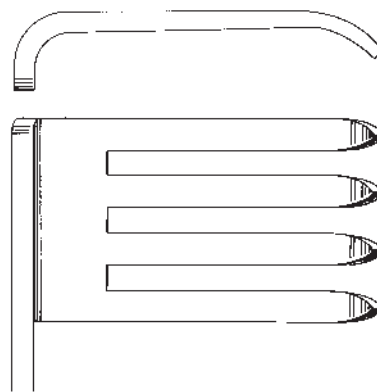

OM 52-0486

Sharp

4 X 4 prongs

OM 52-0490 25mm depth X 25mm height

OM 52-0486 44mm depth X 25mm height

maximum opening: 5 11/16" (145mm)

Blunt

4 X 4 prongs

OM 52-0484 25mm depth X 25mm height

OM 52-0488 44mm depth X 25mm height

maximum opening: 6" (152mm)

BECKMAN-ADSON LAMINECTOMY RETRACTOR

12 1/4" (311mm) with hinged blades

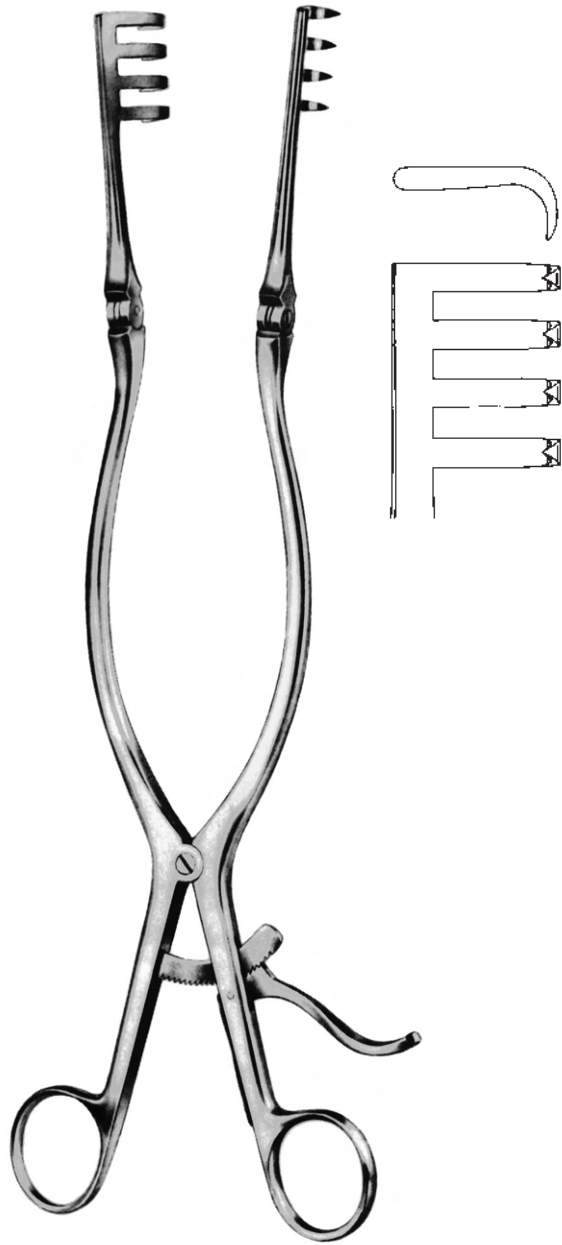

OM 52-0470
with hinged blades
12 1/4" (311mm)
4 X 4 with sharp prongs
17mm depth X 27mm height
maximum opening: 6 7/16"

OM 52-0472
12 1/4" (311mm)
with hinged blades
4 X 4 with blunt prongs
17mm depth X 27mm height
maximum opening: 6 7/16"

BECKMAN RETRACTOR

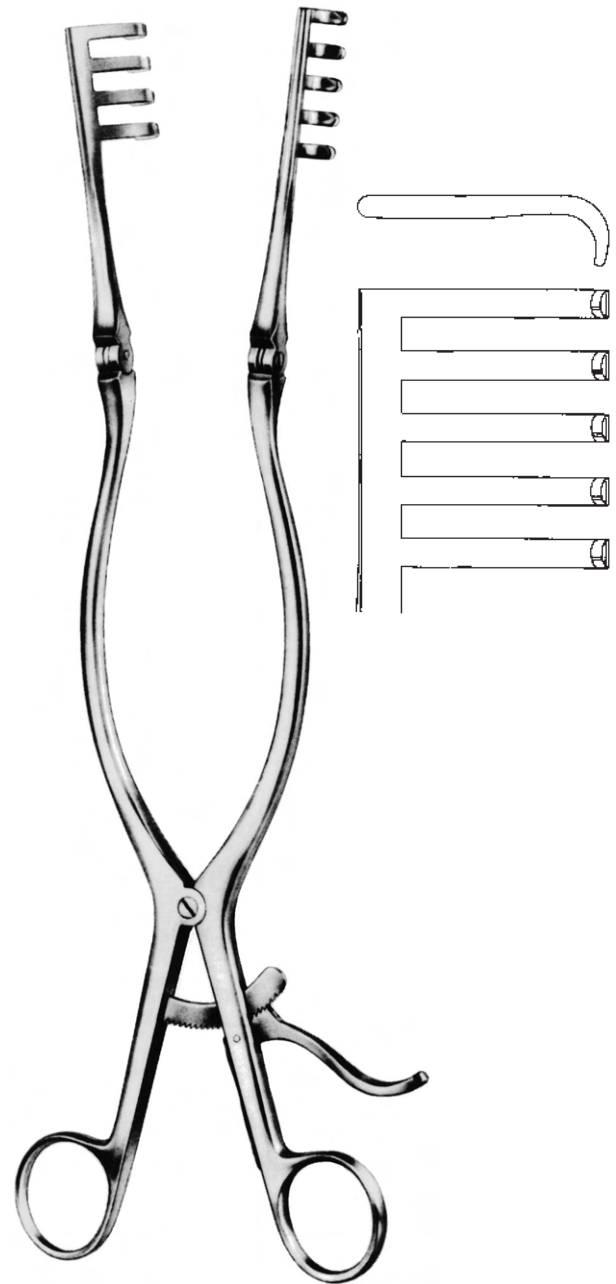

OM 52-0474
12 1/2" (318mm)
with hinged blades
4 X 5 with blunt prongs
25mm depth X 37mm height
maximum opening: 6 15/16"

ADSON RETRACTOR

Primarily used to retract detached trochanter from the stump of the femoral neck. Hinged arms allow handles to be angled away from surgical site to minimize interference.

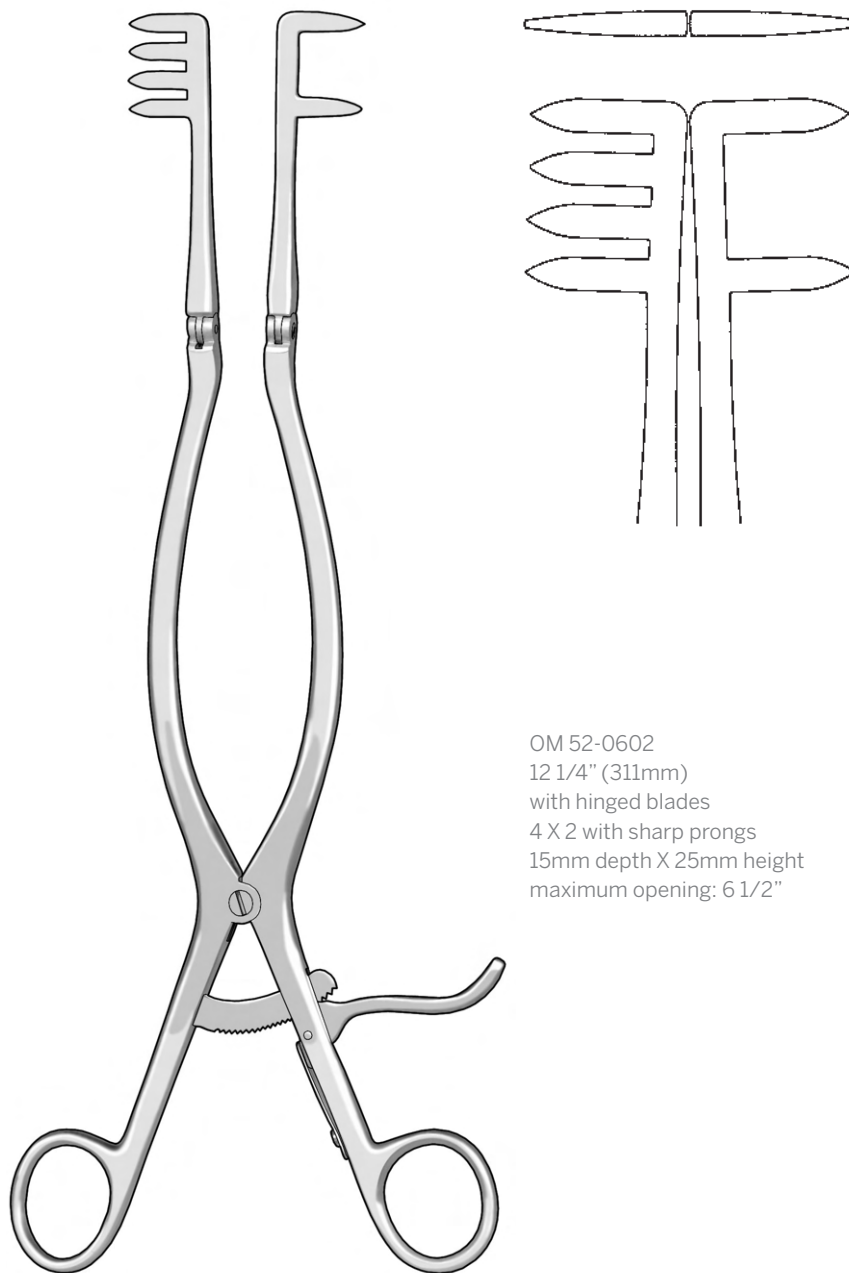

OM 52-0602
12 1/4" (311mm)
with hinged blades
4 X 2 with sharp prongs
15mm depth X 25mm height
maximum opening: 6 1/2"

HORIZONTAL RETRACTOR

OM 52-0380
3 1/2" (89mm) spread
fenestrated

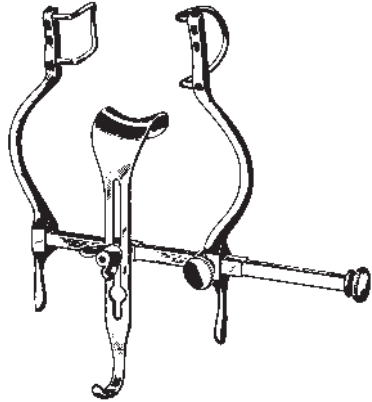

BALFOUR RETRACTOR

Pediatric

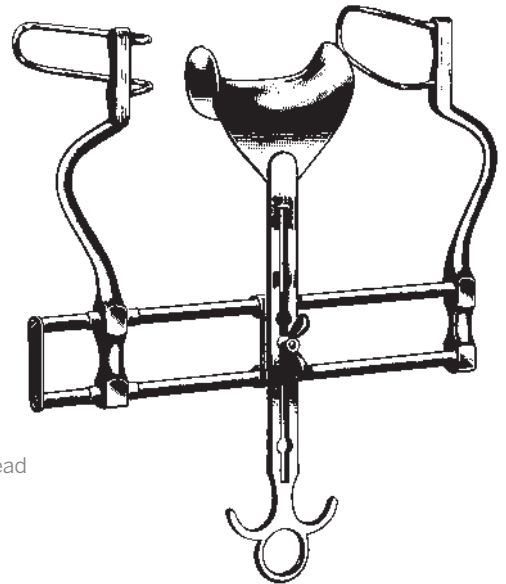

OM 52-0358
7" (178mm) spread
fenestrated

BALFOUR RETRACTOR

Adult

Note:

- Specially designed thin serrated blades fit anatomically correct against the metatarsals.
- Precise design and German manufacture assure slip-proof hold on metatarsals.
- Affords excellent visibility for the surgeon.
- Designed by Dr. Kenneth Cox.

OM 58-0240
4 1/2" (114mm)

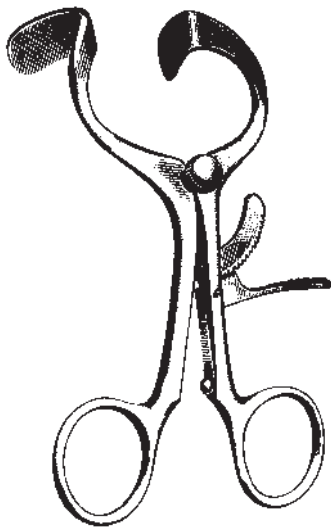

MALTZ-SEEBURGER RETRACTOR

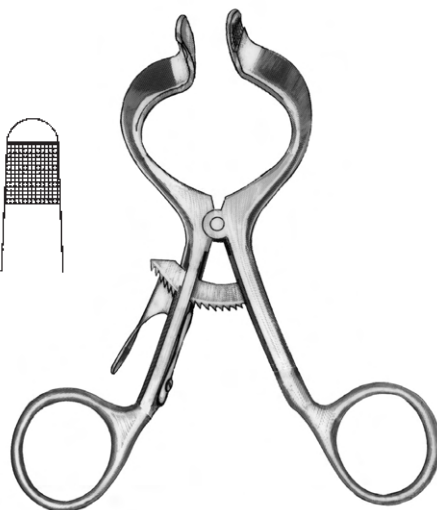
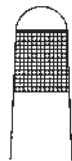

COX METATARSAL SPREADER

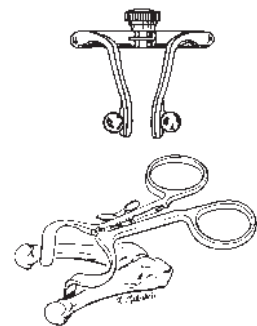

OM 69-0990
4 1/2" (114mm)
8mm width X 28mm depth
blades



SCOVILLE HEMILAMINECTOMY RETRACTOR BODY

OM 55-0445
 spread: 6 3/4" (172mm)
 arm length: 5 1/2" (140mm)

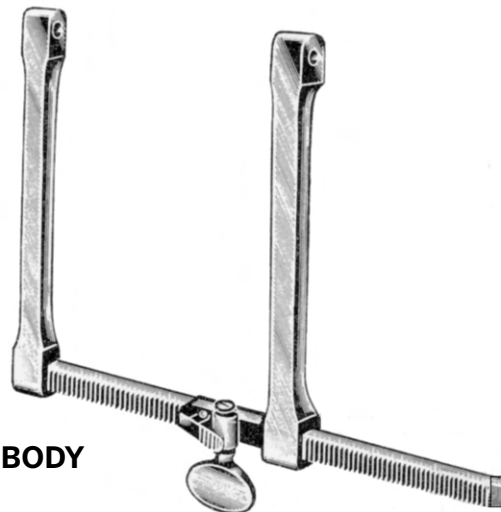

HAVERFIELD-SCOVILLE HEMILAMINECTOMY RETRACTOR BODY

OM 55-0445
 spread: 6 3/4" (172mm)
 arm length: 5 1/2" (140mm)

SCOVILLE BLADES

Hook style
 OM 55-0447 2" depth (51mm)
 OM 55-0448 3" depth (76mm)
 OM 55-0449 2" depth (51mm), with cross bar
 OM 55-0450 2 3/4" depth (70mm), with cross bar



SCOVILLE BLADES

Solid
 OM 55-0451 1" width X 2 1/2" depth (25mm X 64mm)
 OM 55-0452 2" width X 2 1/2" depth (51mm X 64mm)
 OM 55-0453 1 1/8" width X 2 5/8" depth (29mm X 67mm)
 OM 55-0454 1" width X 3 1/2" depth (25mm X 89mm)

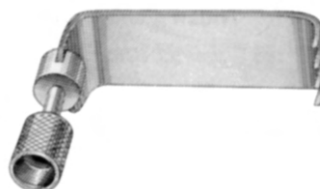

SCOVILLE BLADES

4 prong
 OM 55-0456 1 1/2" width X 1 5/8" depth (38mm X 41mm)
 OM 55-0457 1 7/8" width X 2 5/8" depth (48mm X 67mm)



MEYERDING BLADES

OM 55-0458 1" width X 2 1/4" depth (25mm X 57mm)
 OM 55-0459 1" width X 3" depth (25mm X 76mm)
 OM 55-0460 2" width X 3 1/2" depth (51mm X 89mm)

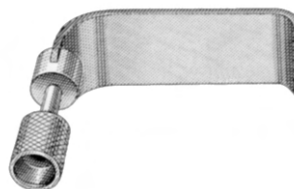

HIBBS BLADES

OM 55-0461 1" width X 2" depth (25mm X 51mm)
 OM 55-0462 2" width X 2" depth (51mm X 51mm)
 OM 55-0463 1" width X 2 1/2" depth (25mm X 64mm)
 OM 55-0464 1 1/2" width X 2 1/2" depth (38mm X 64mm)
 OM 55-0465 1" width X 3" depth (25mm X 76mm)
 OM 55-0466 1 1/2" width X 3" depth (38mm X 76mm)
 OM 55-0467 2" width X 3" depth (51mm X 76mm)
 OM 55-0468 1" width X 4" depth (25mm X 102mm)
 OM 55-0469 2" width X 4" depth (51mm X 102mm)

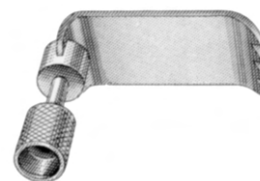

TAYLOR SPINAL BLADES

OM 55-0471 1 1/4" width X 3" depth (32mm X 76mm)
 OM 55-0472 1 1/4" width X 4" depth (32mm X 102mm)

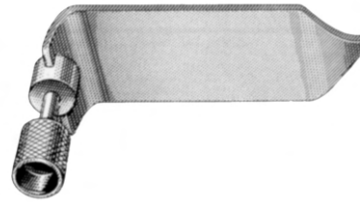

TAYLOR LAMINECTOMY BLADES

3 prong
 OM 55-0473 1 1/2" width X 1 3/4" depth (38mm X 44mm)

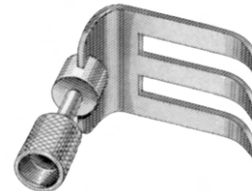

TAYLOR LAMINECTOMY BLADES

4 prong
 OM 55-0474 2" width X 1 7/8" depth (51mm X 48mm)
 OM 55-0475 2 1/2" width X 2 1/2" depth (64mm X 64mm)
 OM 55-0476 2 1/4" width X 3 1/8" depth (57mm X 79mm)

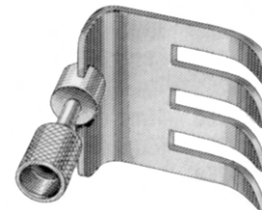

OM 61-0338
 5 1/4" (133mm) bi-valve

TROSSEAU DILATOR

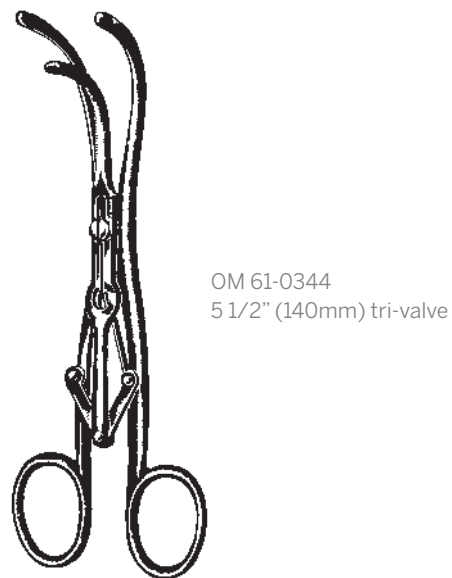

OM 61-0344
 5 1/2" (140mm) tri-valve

LA BORDE DILATOR



OM KO 7248-38 4cm deep prongs
OM KO 7248-40 7cm deep prongs
OM KO 7248-50 10cm deep prongs

SCOLIOSIS OR TOTAL HIP RETRACTOR

11 3/4" (30cm)

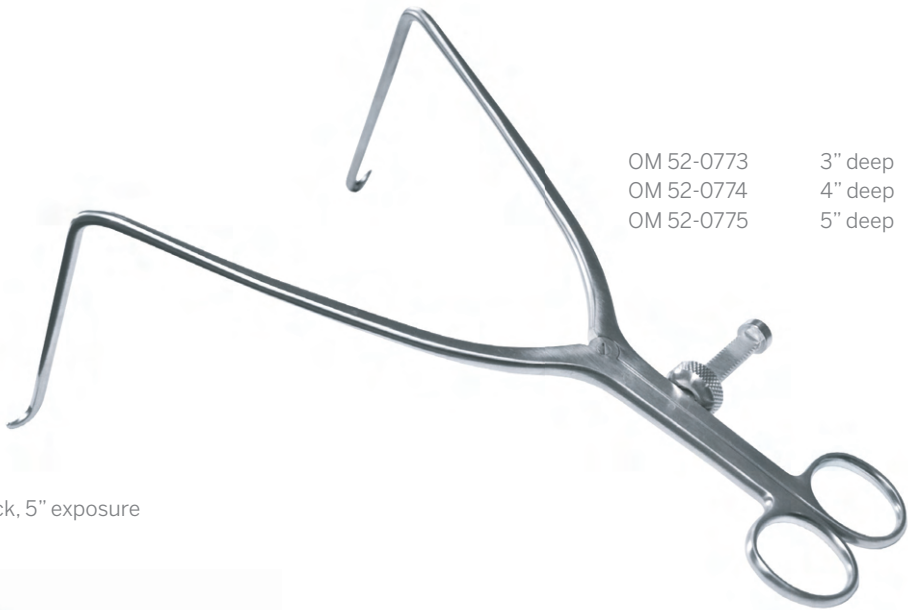

OM 52-0773 3" deep
 OM 52-0774 4" deep
 OM 52-0775 5" deep

SPINE RETRACTOR

90 degree retractor with speed lock, 5" exposure



OM 94-0100
 12 1/4"
 w/2 teeth

MCBRIDE SPINAL RETRACTOR

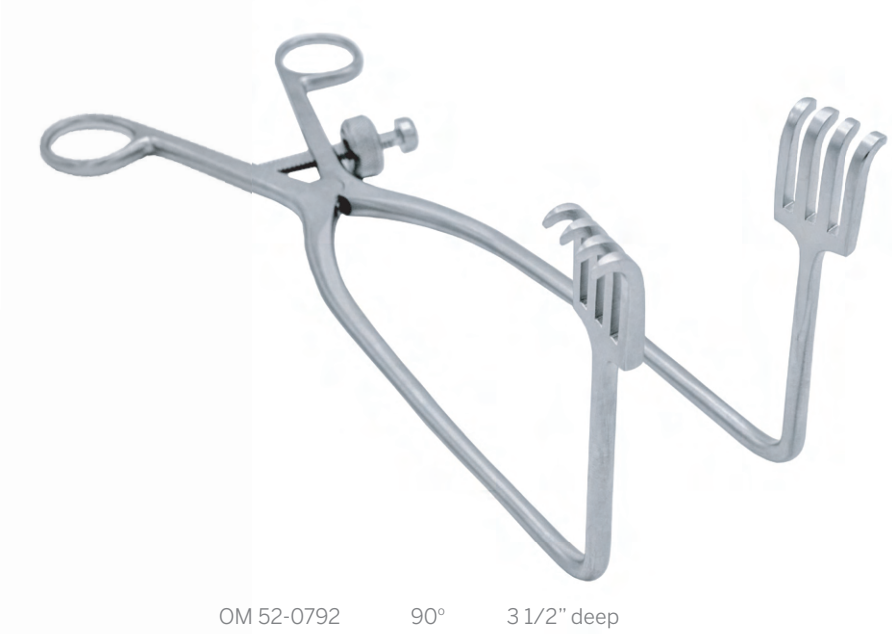

OM 52-0792 90° 3 1/2" deep
 OM 52-0794 90° 3" deep
 OM 52-0795 90° 4" deep
 OM 52-0793 45° 3 1/2" deep

DEEP ANGLE RETRACTOR

cerebellar tips

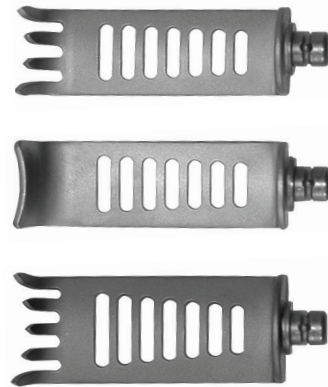

CCR BLADES

4 teeth medial/lateral, titanium, green

OM 96-0200	19mm	25mm
OM 96-0201	19mm	30mm
OM 96-0202	19mm	35mm
OM 96-0203	19mm	40mm
OM 96-0204	19mm	45mm
OM 96-0205	19mm	50mm
OM 96-0206	19mm	55mm
OM 96-0207	19mm	60mm
OM 96-0208	19mm	65mm
OM 96-0209	19mm	70mm
OM 96-0210	19mm	75mm

blunt longitudinal, titanium, green

OM 96-0211	19mm	25mm
OM 96-0212	19mm	30mm
OM 96-0213	19mm	35mm
OM 96-0214	19mm	40mm
OM 96-0215	19mm	45mm
OM 96-0216	19mm	50mm
OM 96-0217	19mm	55mm
OM 96-0218	19mm	60mm
OM 96-0219	19mm	65mm
OM 96-0220	19mm	70mm
OM 96-0221	19mm	75mm

8 teeth lateral, titanium, blue

OM 96-0222	24mm	25mm
OM 96-0223	24mm	30mm
OM 96-0224	24mm	35mm
OM 96-0225	24mm	40mm
OM 96-0226	24mm	45mm
OM 96-0227	24mm	50mm
OM 96-0228	24mm	55mm
OM 96-0229	24mm	60mm
OM 96-0230	24mm	65mm
OM 96-0231	24mm	70mm
OM 96-0232	24mm	75mm

5 teeth medial, titanium, blue

OM 96-0233	24mm	25mm
OM 96-0234	24mm	30mm
OM 96-0235	24mm	35mm
OM 96-0236	24mm	40mm
OM 96-0237	24mm	45mm
OM 96-0238	24mm	50mm
OM 96-0239	24mm	55mm
OM 96-0240	24mm	60mm
OM 96-0241	24mm	65mm
OM 96-0242	24mm	70mm
OM 96-0243	24mm	75mm

blunt longitudinal, titanium, blue

OM 96-0244	24mm	25mm
OM 96-0245	24mm	30mm
OM 96-0246	24mm	35mm
OM 96-0247	24mm	40mm
OM 96-0248	24mm	45mm
OM 96-0249	24mm	50mm
OM 96-0250	24mm	55mm
OM 96-0251	24mm	60mm
OM 96-0252	24mm	65mm
OM 96-0253	24mm	70mm
OM 96-0254	24mm	75mm



Casper Cervical Retractor basic counter retractor, double hinge, distal hinge titanium, radiolucent.

SPINE RETRACTOR

8" (203mm)
OM 96-0169



OM 96-0139 right body 2 1/2" spread
OM 96-0140 right body 3 1/4" spread, long bar
OM 96-0147 right drill guide black Radel handle

CASPER DISTRACTOR RIGHT



OM 96-0147



OM 96-0137 left body 2 1/2" spread
OM 96-0136 left body 3 1/4" spread, long bar
OM 96-0146 left drill guide black Radel handle

CASPER DISTRACTOR LEFT



OM 96-0146

OM 96-0162 5 3/4" (146mm), 8mm depth
OM 96-0160 5 3/4" (146mm), 14mm depth



TWIST DRILL FOR DISTRACTION SCREWS

1.7mm diameter

OM 96-0150 with black Radel handle



OM 96-0156 12mm
OM 96-0157 14mm
OM 96-0158 16mm
OM 96-0159 18mm

SCREWDRIVER FOR DISTRACTION SCREWS

8" (203mm)

DISTRACTION SCREWS

non sterile

Note:

To add Fiberoptic Light, add "L" to the product number.
To add Suction, add "S" to the product number.
To add Fiberoptic and Suction, add "LS" to the product number.
To add Endoscopic Sheath, add "E" to the product number.

Note: Each OrthoMed Endo-Retractor can be fitted with fiberoptic light and with suction. When intended for use with an endoscope, the Endo-Retractor will have the appropriate endoscope sheath mounted to it. OrthoMed Endo-Retractors feature UNIVERSAL light cord adapters that are compatible with Storz®, Wolf®, ACMI®, Olympus®, and most other fittings.



Shown with suction and fiberoptic light.

OM MA 110-681	30.0mm X 9.0cm
OM MA 110-682	24.0mm X 9.0cm
OM MA 110-683	36.0mm X 16.0cm
OM MA 110-684	36.0mm X 19.0cm
OM MA 110-685	25.0mm X 10.0cm
OM MA 110-686	25.0mm X 12.0cm
OM MA 110-687	30.0mm X 12.0cm
OM MA 110-688	25.0mm X 15.0cm
OM MA 110-689	30.0mm X 15.0cm
OM MA 110-690	16.0mm X 8.0cm

TEBBETTS STYLE

Note:

To add Fiberoptic Light, add "L" to the product number.
To add Suction, add "S" to the product number.
To add Fiberoptic and Suction, add "LS" to the product number.
To add Endoscopic Sheath, add "E" to the product number.

Shown with suction and fiberoptic light.

OM MA 110-671	14.0mm X 7.0cm
OM MA 110-672	14.0mm X 9.0cm
OM MA 110-673	23.0mm X 15.0cm
OM MA 110-674	23.0mm X 18.0cm



FERRIERA STYLE

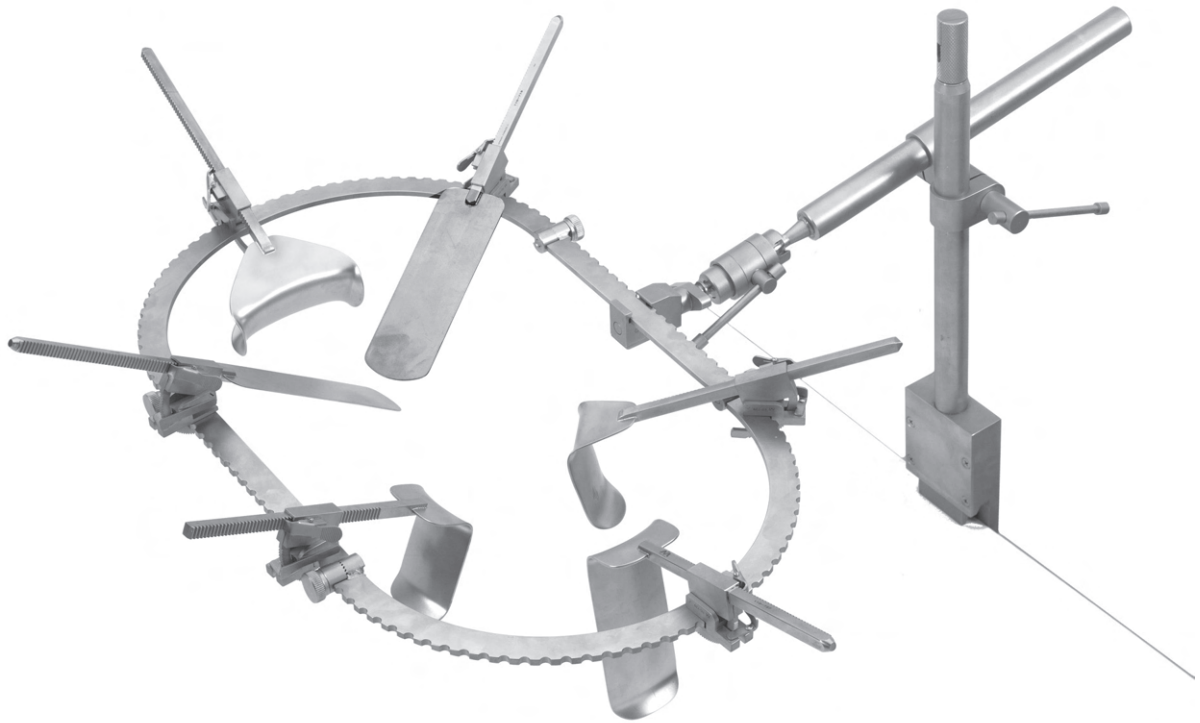

Complete set.
OM COD 50-4542

Set includes:

OM COD 50-4581	Table Post
OM COD 50-4552	Horizontal Bar
OM COD 50-4554	1" Post Coupling
OM COD 50-4557	Medium Oval Ring
OM COD 50-4561	2" x 6" (51mm X 152mm) Malleable Retractor (2 ea.)
OM COD 50-4568	2" x 3" (51mm X 76mm) Kelly Retractor (2 ea.)
OM COD 50-4569	2" x 4" (51mm X 102mm) Kelly Retractor
OM COD 50-4576	Balfour Retractor
OM COD 50-4579	Ratchet Mechanism (2 ea.)
OM COD 50-4580	Tilt Ratchet Mechanism (6 ea.)
OM COD 50-4583	Segmented Ring
OM COD 50-4562	1 1/2" x 6" (38mm X 152mm) Malleable Retractor
OM COD 50-4567	3" x 6" (76mm X 152mm) Malleable Retractor
OM COD 50-4570	2" x 5" (51mm X 127mm) Kelly Retractor
OM COD 50-4571	2" x 6" (51mm X 152mm) Kelly Retractor
OM COD 50-4582	Horizontal Flex Bar
OM COD 50-4566	Harrington Retractor
OM COD 50-4577	Gelpi Retractor

Accessories:

OM COD 50-4507	Table Fixation and Ring Case
OM COD 50-4508	Blades and Accessories Case

MULTI TRAC RETRACTOR SET

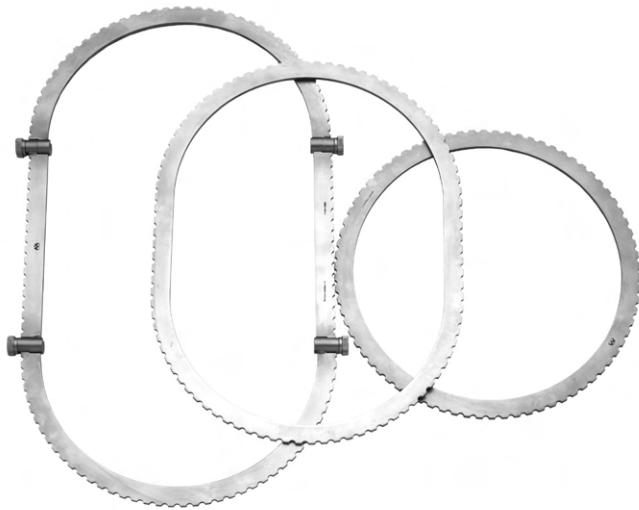

OM MA 110-716 10 1/2" (267mm) round ring

OM COD 50-4557 10 1/2" x 14 1/2" (267mm X 495mm) oval ring

OM COD 50-4583 10 1/2" x 19 1/2" (267mm X 368mm) segmented ring

RETRACTOR RINGS

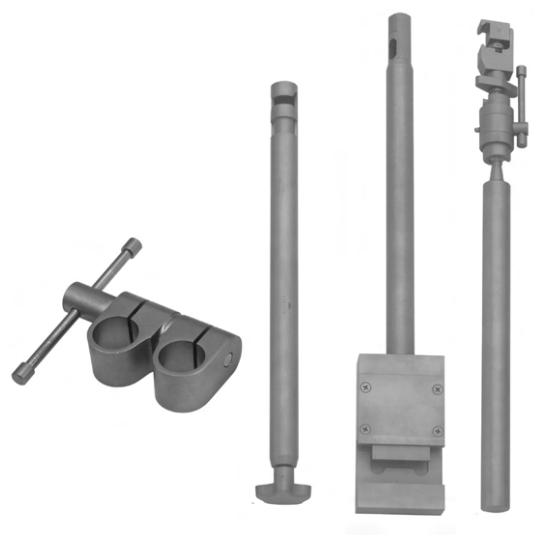

OM COD 50-4554
OM COD 50-4581
OM COD 50-4552
OM COD 50-4582

1" (25mm) post coupler
Table post
Horizontal bar
Horizontal flex bar

TABLE MOUNTING COMPONENTS

Allows extension or retraction along the horizontal axis and allows vertical movement of retractor blade with a second ratchet.

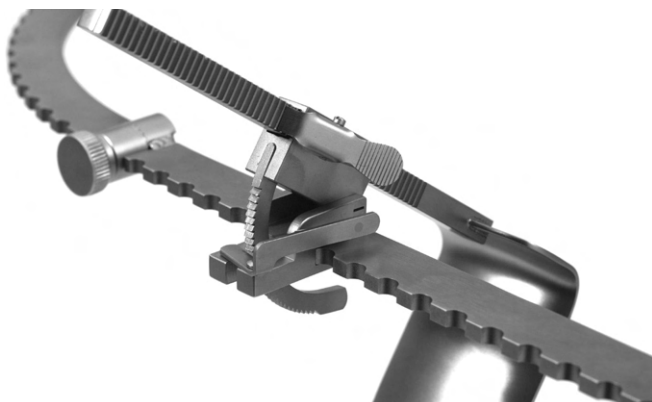

TILT RATCHET MECHANISM

OM COD 50-4580

Allows extension or retraction along the horizontal axis at 2mm intervals.



FIXED RATCHET MECHANISM

OM COD 50-4579



- OM MA 110-834 2 1/2" x 3" (64mm X 76mm) blades
- OM COD 50-4568 2" x 3" (51mm X 76mm) blades
- OM COD 50-4569 2" x 4" (51mm X 102mm) blades
- OM COD 50-4570 2" x 5" (51mm X 127mm) blades

KELLY BLADES

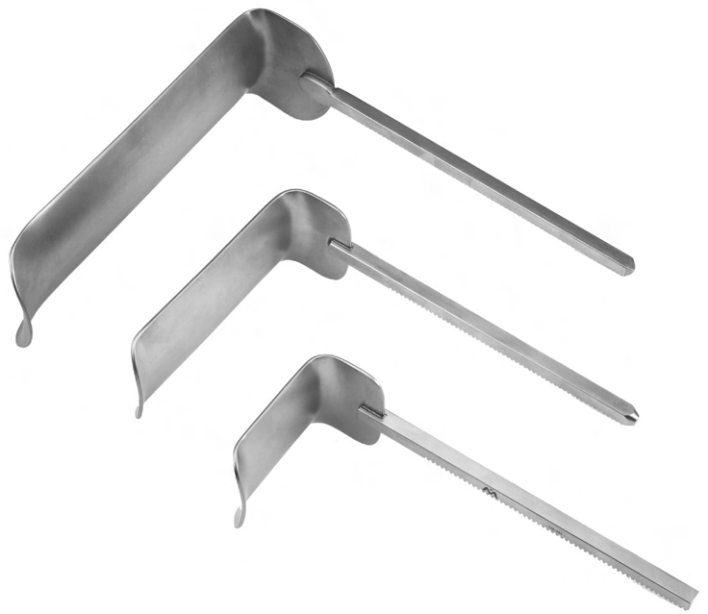

- OM MA 110-837 2 1/2" x 10" (64mm X 254mm) blades
- OM COD 50-4571 2" x 6" (51mm X 152mm) blades
- OM MA 110-836 2 1/2" x 8" (64mm X 203mm) blades



- OM MA 110-811 1" x 5" (25mm X 127mm)
- OM MA 110-812 1" x 6" (25mm X 152mm)
- OM MA 110-813 6" x 12" (152mm X 305mm)
- OM MA 110-814 1" x 9" (25mm X 229mm)
- OM MA 110-815 2" x 7" (51mm X 178mm)
- OM MA 110-816 3" x 7" (76mm X 178mm)
- OM MA 110-817 2" x 9" (51mm X 229mm)
- OM MA 110-818 2" x 12" (51mm X 305mm)
- OM MA 110-819 3" x 10" (76mm X 254mm)
- OM MA 110-820 3" x 12" (76mm X 305mm)
- OM MA 110-821 4" x 10" (102mm X 254mm)
- OM MA 110-822 4" x 12" (102mm X 305mm)
- OM MA 110-823 6" x 9" (152mm X 229mm)

MALLEABLE RETRACTORS WITH PROTECTIVE EDGE



- OM COD 50-4576 Balfour blade
- OM MA 110-848 Malleable 1/2" x 3" (13mm X 76mm) with lip
- OM COD 50-4577 Gelpi Retractor

SPECIALTY RETRACTORS

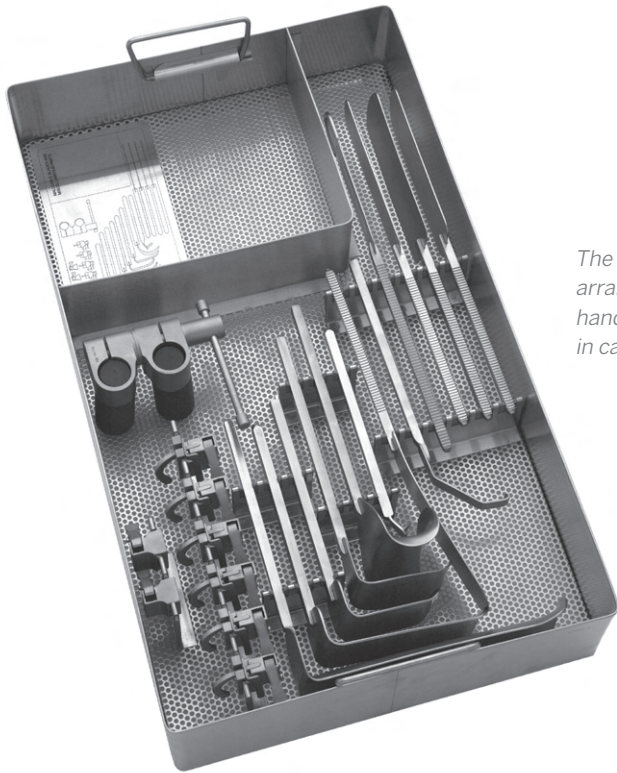

The many components of the Multi Trac retractor set can all be neatly arranged into autoclave sized containers with diagrams that direct instrument handlers on proper placement of each component. A major convenience in care and maintenance of the retractor set.

BLADE AND ACCESSORIES CASE

OM COD 50-4508

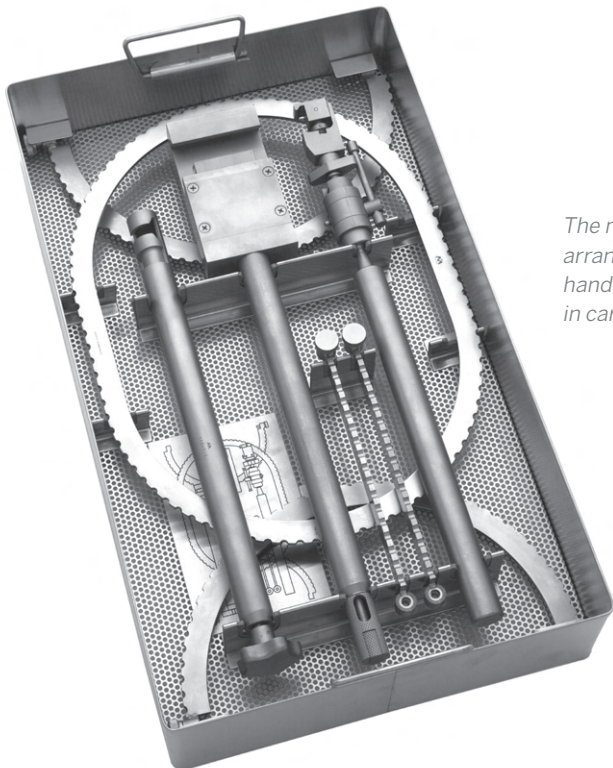

The many components of the Multi Trac retractor set can all be neatly arranged into autoclave sized containers with diagrams that direct instrument handlers on proper placement of each component. A major convenience in care and maintenance of the retractor set.

TABLE FIXATION AND RING CASE

OM COD 50-4507

Thin pads help to separate the femur and tibia during total knee replacement surgery.



OM 90-1875
9 1/4" Pads 22mm X 13mm
Opens to 50mm
with horizontal cut pads

OM 90-1876
7" Pads 22mm X 13mm
Opens to 35mm
with horizontal cut pads

FEMORAL TIBIAL SPREADER

OM 90-1866 10" (254mm) Round disks
OM 90-1865 7" (178mm) Round disks

FEMORAL TIBIAL SPREADER



OM 90-1880 7" (178mm) Smooth pads 15mm x 12mm
OM 90-1881 7" (178mm) Grooved pads 15mm x 12mm

CALCANEAL SPREADER



Long prongs allow use in small, but deep wounds.



OM 90-1875D
Diamond cut pads 10" (254mm)

OM 90-1876D
Diamond cut pads 7" (178mm)

FEMORAL TIBIAL SPREADER



Long prongs allow use in small, but deep wounds.

Maximum opening: 32mm

OM 90-5065	3 X 2 blunt prongs	Blade depth 25mm
OM 90-5066	3 X 2 sharp prongs	Blade depth 25mm
OM 90-5067	3 X 2 blunt prongs	Blade depth 30mm
OM 90-5068	3 X 2 sharp prongs	Blade depth 30mm

DEEP BLADE SMALL WEITLANER RETRACTOR

4 1/2"

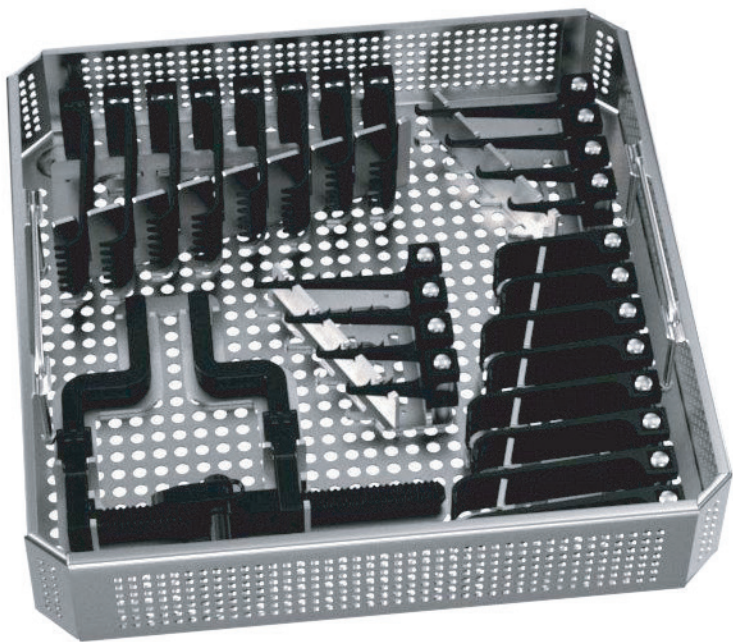

OM NL 9701 (retractor only)
OM NL9701-H (Hinged)
OM NL 9702-01 (full set) with hinged retractor and case



MCCULLOCH RETRACTOR

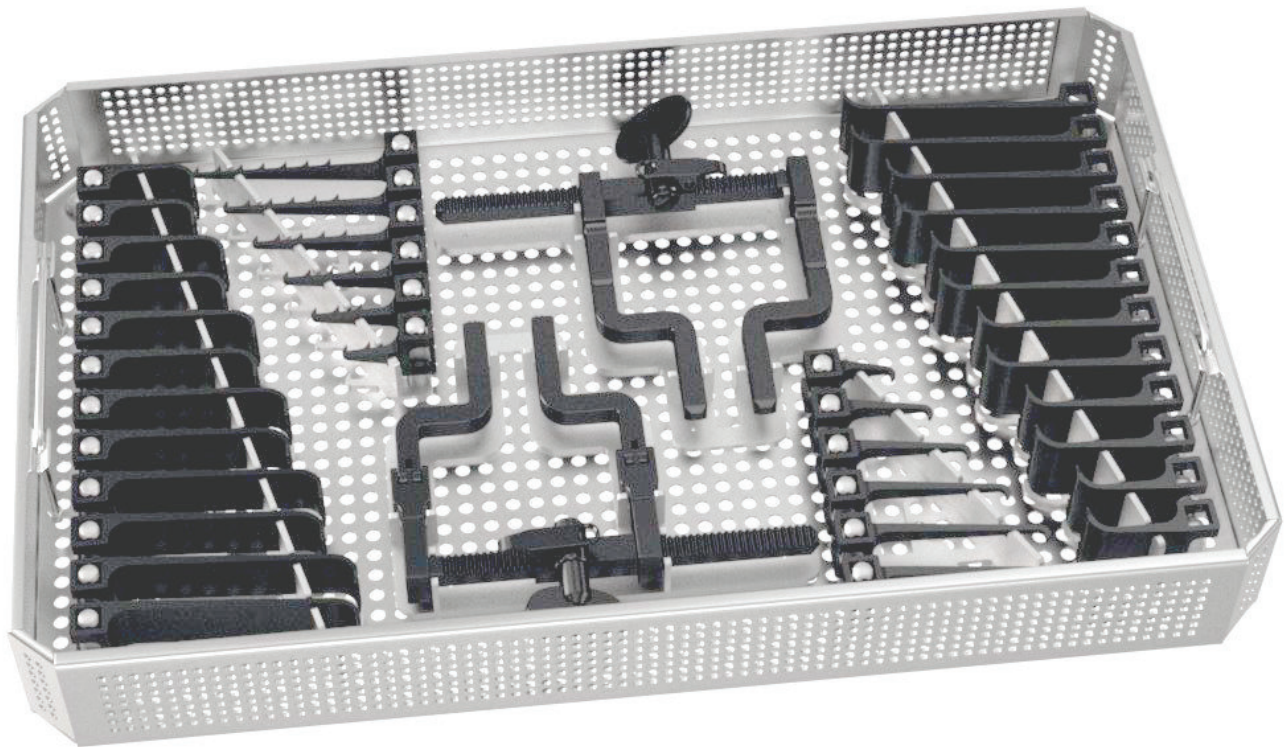

OM NL 9701	McCulloch Retractor Body	Rigid
OM NL 9701-H	McCulloch Retractor Body	Hinged Arms
OM NL 9702-01	Full set McCulloch Retractor with Case Rigid and Hinged	
OM NL 9702-010	Wide Muscle Blade	30x27mm
OM NL 9702-011	Wide Muscle Blade	40x27mm
OM NL 9702-012	Wide Muscle Blade	50x27mm
OM NL 9702-013	Wide Muscle Blade	60x27mm
OM NL 9702-014	Wide Muscle Blade	70x27mm
OM NL 9702-015	Wide Muscle Blade	80x27mm
OM NL 9702-020	Narrow Muscle Blade	30x20mm
OM NL 9702-021	Narrow Muscle Blade	40x20mm
OM NL 9702-022	Narrow Muscle Blade	50x20mm
OM NL 9702-023	Narrow Muscle Blade	60x20mm
OM NL 9702-024	Narrow Muscle Blade	70x20mm
OM NL 9702-025	Narrow Muscle Blade	80x20mm
OM NL 9702-026	Narrow Muscle Blade	90x20mm
OM NL 9702-030	Hook Blade	20mm
OM NL 9702-031	Hook Blade	30mm
OM NL 9702-032	Hook Blade	40mm
OM NL 9702-033	Hook Blade	50mm
OM NL 9702-034	Hook Blade	60mm
OM NL 9702-035	Hook Blade	70mm
OM NL 9702-036	Hook Blade	80mm
OM NL 9702-040	Tooth Blade	20mm
OM NL 9702-041	Tooth Blade	30mm
OM NL 9702-042	Tooth Blade	40mm
OM NL 9702-043	Tooth Blade	50mm
OM NL 9702-044	Tooth Blade	60mm
OM NL 9702-045	Tooth Blade	70mm

MCCULLOCH RETRACTOR