

GENERAL INSTRUMENTS

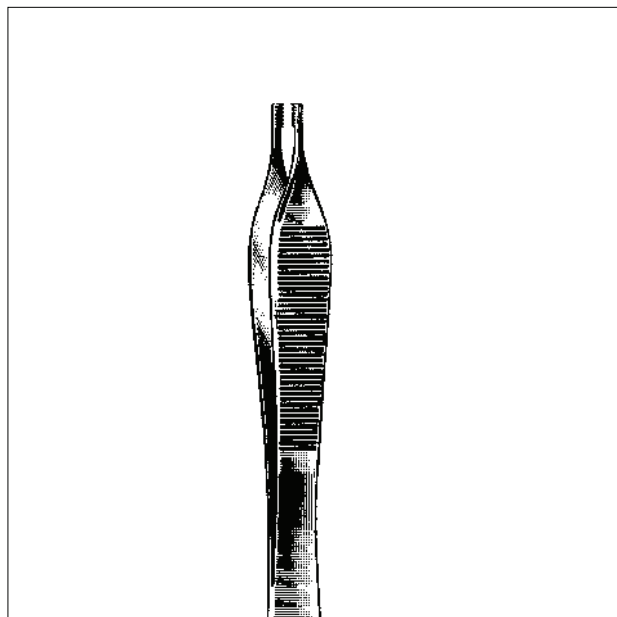

SECTION A



To dissect, hold, clamp, manipulate and suture soft tissue.

ORTHO+MED
The Surgical Instrument Specialists

CONTENTS

Super Cut Scissors	1-3
Operating Scissors	4-7
Dissecting Scissors	4-9
Suture scissors	9-10
Tungsten Carbide Scissors	11-12
Bandage Scissors	13
Utility Scissors/Wire Scissors	14-15
Hemostatic Forceps	15-19
Intestinal Forceps	20-21
Tubing and Utility Forceps	21-20
Towel and Sponge Forceps	22-23
Dressing & Tissue Forceps	23-27
Splinter Forceps	28-29
Needle Holders	29-32
Suction Tubes	33-34
Scalpel Handles	34-35
Probes/Suture Instruments	36-38
Bi-Polar Instruments	38

SUPER-CUT SCISSORS

Super-Cut Scissors represent a truly remarkable advance in scissors technology. Using the finest surgical steel, the latest heat treating methods and master craftsmanship, the upper blade of the scissors is ground to a razor-sharp edge. This process creates scissors with an unprecedented smooth and effective cutting action.

Benefits of Super-Cut Scissors:

- Cut through soft and fibrous tissue without effort.
- Superb control permits precision in dissection.
- Less hand fatigue for the surgeon and less trauma for the patient.
- Retain sharpness longer than ordinary scissors.
- Ring handles are black-coated for easy identification.
- Fully autoclavable.
- Backed by OrthoMed's lifetime guarantee.
- Not recommended for fiberglass or plaster splints.

Surgeons who use our Super-Cut Scissors are convinced of their superior performance and won't do without them on their surgical trays.

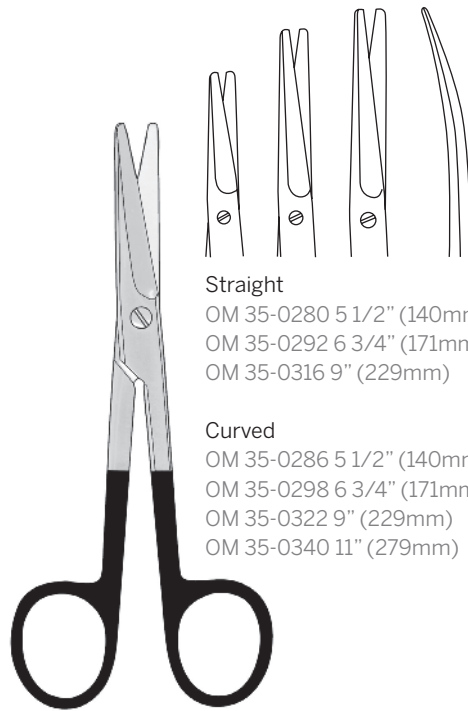

Straight
 OM 35-0280 5 1/2" (140mm)
 OM 35-0292 6 3/4" (171mm)
 OM 35-0316 9" (229mm)

Curved
 OM 35-0286 5 1/2" (140mm)
 OM 35-0298 6 3/4" (171mm)
 OM 35-0322 9" (229mm)
 OM 35-0340 11" (279mm)

SUPER-CUT MAYO SCISSORS
 Beveled blades, blunt points

Flat, blunt scissors for dissecting soft tissue.



Straight
 OM 35-0364
 4 1/2" (114mm)
 blunt points

Curved
 OM 35-0370
 4 1/2" (114mm)
 blunt points

SUPER-CUT BABY METZENBAUM SCISSORS



SUPER-CUT METZENBAUM SCISSORS
 Blunt point

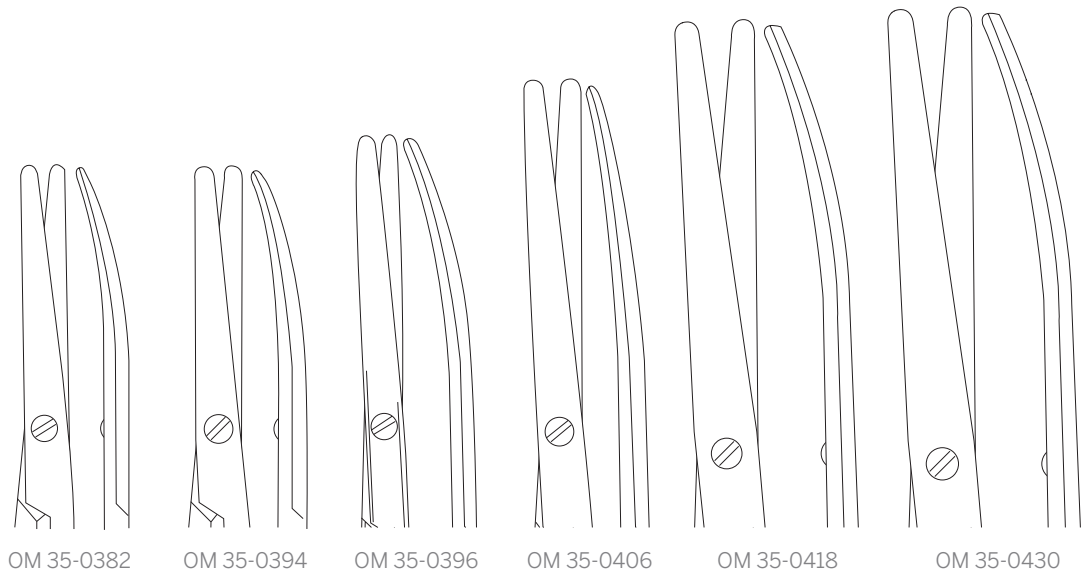

Straight
 OM 35-0380 6" (152mm)
 OM 35-0392 7" (171mm)

Curved
 OM 35-0382 6" (152mm)
 OM 35-0394 7" (178mm)
 OM 35-0396 7" (178mm)
 OM 35-0406 8" (203mm)
 OM 35-0418 9" (229mm)
 OM 35-0430 11" (279mm)

delicate

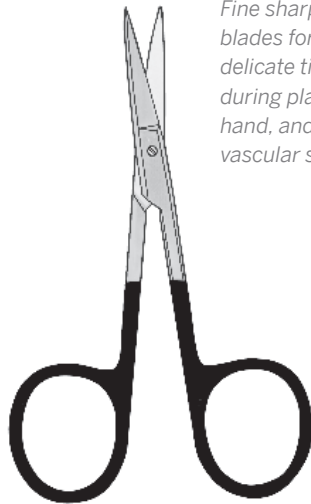

Fine sharp/sharp blades for cutting delicate tissue during plastic, hand, and minor vascular surgery.

SUPER-CUT IRIS SCISSORS

Sharp points

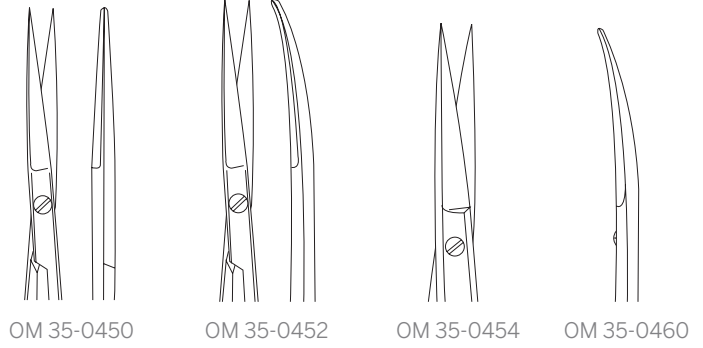

OM 35-0450

OM 35-0452

OM 35-0454

OM 35-0460

Straight

OM 35-0450 3 1/2" (89mm) delicate
OM 35-0454 4 1/2" (114mm)

Curved

OM 35-0452 3 1/2" (89mm) delicate
OM 35-0460 4 1/2" (114mm)

Delicate short narrow tips for dissecting fine tissue.



SUPER-CUT STEVENS SCISSORS

Blunt points

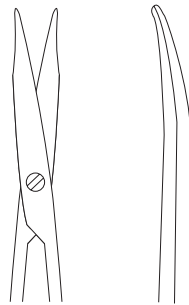

Straight

OM 35-0484 4 1/2" (114mm)

Curved

OM 35-0490 4 1/2" (114mm)
OM 35-0494 5 1/4" (133mm)



SUPER-CUT JAMISON SCISSORS

6 1/4" (159mm)

Very delicate blunt scissors with long handles for fine tissue dissection.



OM 35-0496 curved blunt points very delicate

OrthoMed developed these remarkably sharp scissors in response to the demands of doctors, nurses, and other O.R. personnel.

Hospital tests show that these scissors cut multiple layers of stockinette bandages, drapes, and moleskin with ease.

- Very little strength is required for cutting, putting less strain on thumb and forearm.
- Perfect cutting control because you don't have to force them to cut.
- Scissors cut faster, saving critical time in the O.R.
- Retain their sharpness longer than ordinary scissors.
- Not recommended for cutting plaster.

The delicate offset shanks and the sharp Super-Cut edge provide better leverage. The fine knob slides easily under finger and toe bandages.



OM 35-0202
5 1/2" (140mm)
shanks angled on side

SUPER-CUT HI-LEVEL BANDAGE SCISSORS

Cuts bandages and multiple layers of dressing with ease. Razor-sharp blades reduce hand fatigue.

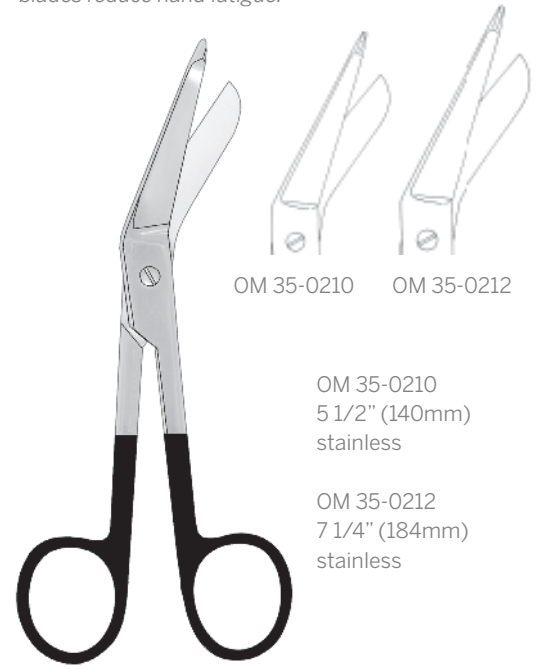

OM 35-0210 OM 35-0212

OM 35-0210
5 1/2" (140mm)
stainless

OM 35-0212
7 1/4" (184mm)
stainless

SUPER-CUT LISTER BANDAGE SCISSORS

All the benefits of our Super-Cut Lister Scissors plus an oversized finger ring, which helps relieve pressure on the third metacarpal.



OM 35-0214
8" (203 mm)
stainless

SUPER-CUT LISTER BANDAGE SCISSORS WITH LARGE FINGER RING

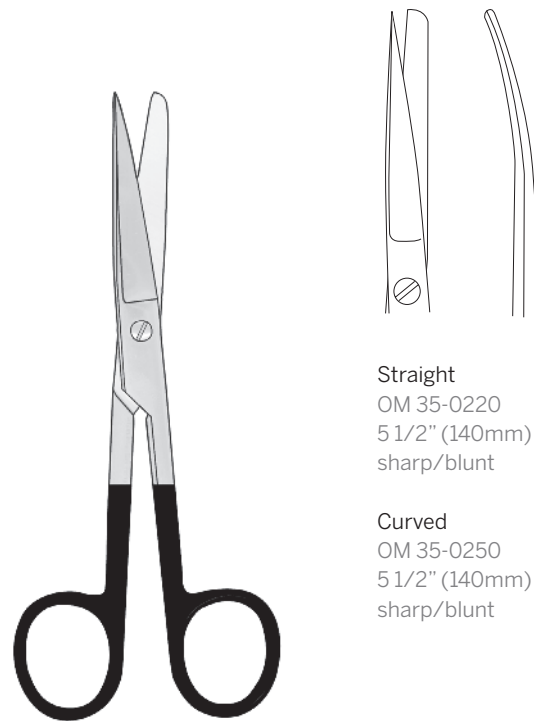

Straight
OM 35-0220
5 1/2" (140mm)
sharp/blunt

Curved
OM 35-0250
5 1/2" (140mm)
sharp/blunt

SUPER-CUT OPERATING SCISSORS

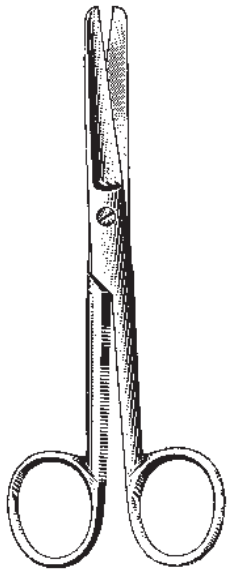

OPERATING SCISSORS

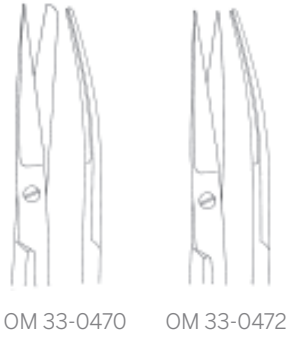

OM 33-0470 OM 33-0472



OM 33-0474

Straight

- OM 33-0300 4 1/2" (114mm) sharp/blunt
- OM 33-0302 4 1/2" (114mm) sharp/sharp
- OM 33-0304 4 1/2" (114mm) blunt/blunt
- OM 33-0310 5" (127mm) sharp/blunt
- OM 33-0312 5" (127mm) sharp/sharp
- OM 33-0314 5" (127mm) blunt/blunt
- OM 33-0320 5 1/2" (140mm) sharp/blunt
- OM 33-0322 5 1/2" (140mm) sharp/sharp
- OM 33-0324 5 1/2" (140mm) blunt/blunt
- OM 33-0370 6 1/2" (165mm) sharp/blunt
- OM 33-0372 6 1/2" (165mm) sharp/sharp
- OM 33-0374 6 1/2" (165mm) blunt/blunt

Curved

- OM 33-0470 4 1/2" (114mm) sharp/blunt
- OM 33-0472 4 1/2" (114mm) sharp/sharp
- OM 33-0474 4 1/2" (114mm) blunt/blunt
- OM 33-0482 5" (127mm) sharp/blunt
- OM 33-0484 5" (127mm) sharp/sharp
- OM 33-0486 5" (127mm) blunt/blunt
- OM 33-0490 5 1/2" (140mm) sharp/blunt
- OM 33-0492 5 1/2" (140mm) sharp/sharp
- OM 33-0494 5 1/2" (140mm) blunt/blunt
- OM 33-0520 6 1/2" (165mm) sharp/sharp
- OM 33-0522 6 1/2" (165mm) sharp/sharp
- OM 33-0524 6 1/2" (165mm) blunt/blunt

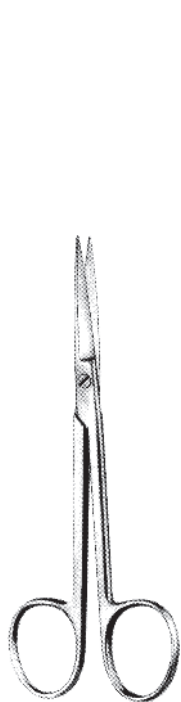

PLASTIC SURGERY SCISSORS

4 3/4" (121mm)



OM 33-0532 OM 33-0538

Straight

- OM 33-0532 sharp/sharp
- OM 33-0534 sharp/blunt
- OM 33-0536 blunt/blunt

Curved

- OM 33-0538 sharp/sharp
- OM 33-0540 sharp/blunt
- OM 33-0542 blunt/blunt

Angled on side

- OM 33-0544 sharp/sharp

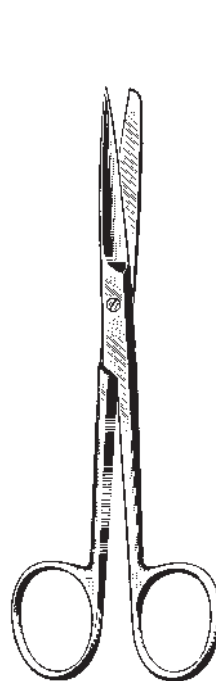

DEAVER SCISSORS

5 1/2" (140mm)



OM 34-0142

Most scissors can be serrated upon request.

Straight

- OM 34-0140 sharp/blunt
- OM 34-0142 sharp/sharp

Curved

- OM 34-0150 sharp/blunt
- OM 34-0152 sharp/sharp



Straight
 OM 53-0330 6" (152mm)
 OM 53-0332 7" (179mm)

Curved
 OM 53-0331 6" (152mm)
 OM 53-0333 7" (179mm)

REYNOLDS SCISSORS
 blunt points

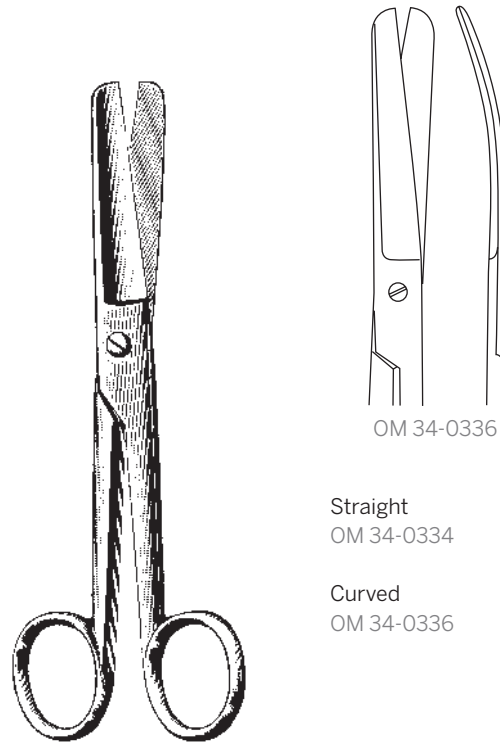

OM 34-0336

Straight
 OM 34-0334

Curved
 OM 34-0336

DOYEN ABDOMINAL SCISSORS
 7" (178mm)

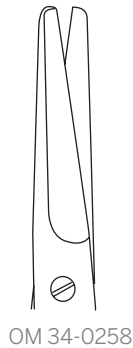
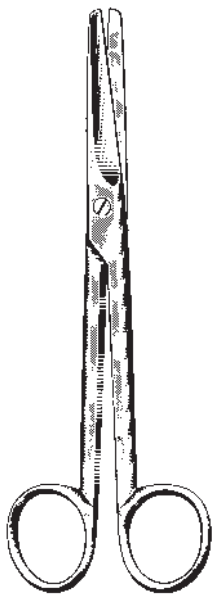

Straight
 OM 34-0256 5 1/2" (140mm)
 OM 34-0260 6 3/4" (171mm)
 OM 34-0292 9" (229mm)

Curved
 OM 34-0258 5 1/2" (140mm)
 OM 34-0262 6 3/4" (171mm)
 OM 34-0294 9" (229mm)

Serrated
 OM 34-0280 6 3/4" (171mm)
 OM 34-0282 6 3/4" (171mm)

MAYO SCISSORS
 Beveled blades

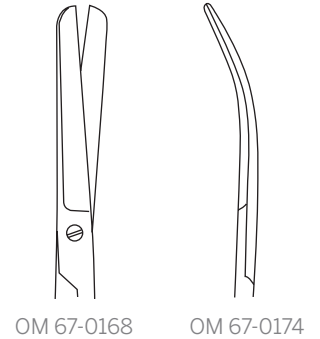
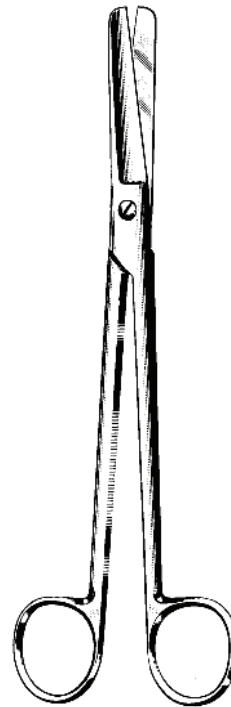

Straight
 OM 67-0164 sharp/sharp
 OM 67-0166 sharp/blunt
 OM 67-0168 blunt/blunt

Curved
 OM 67-0170 sharp/sharp
 OM 67-0172 sharp/blunt
 OM 67-0174 blunt/blunt

SIMS SCISSORS
 8" (203mm)

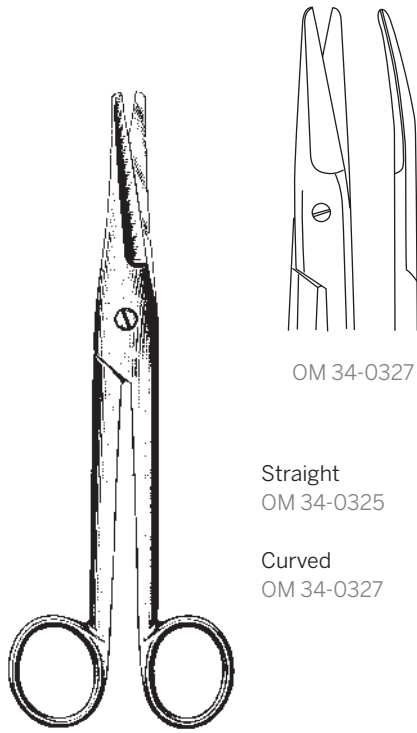

OM 34-0327

Straight
OM 34-0325

Curved
OM 34-0327

MAYO-NOBLE SCISSORS
6 1/2" (165mm) Beveled blades

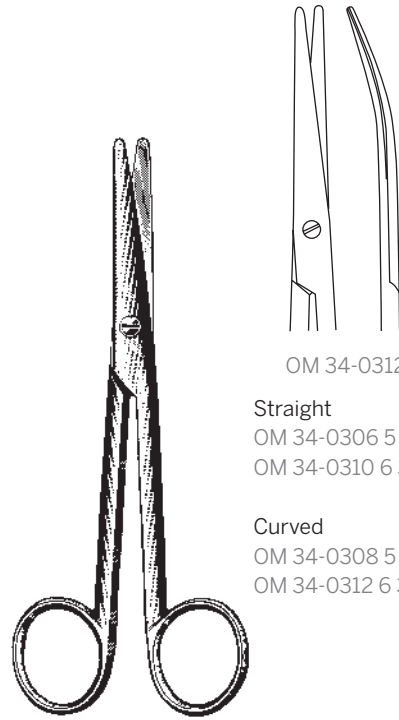

OM 34-0312

Straight
OM 34-0306 5 1/2" (140mm)
OM 34-0310 6 3/4" (171mm)

Curved
OM 34-0308 5 1/2" (140mm)
OM 34-0312 6 3/4" (171mm)

MAYO-STILLE SCISSORS
Rounded blades



OM 34-0338

FERGUSON SCISSORS
7" (178mm)
Angled on flat



OM 34-0354

Straight
OM 34-0348

Curved
OM 34-0354

SISTRUNK SCISSORS
5" (127mm) Delicate

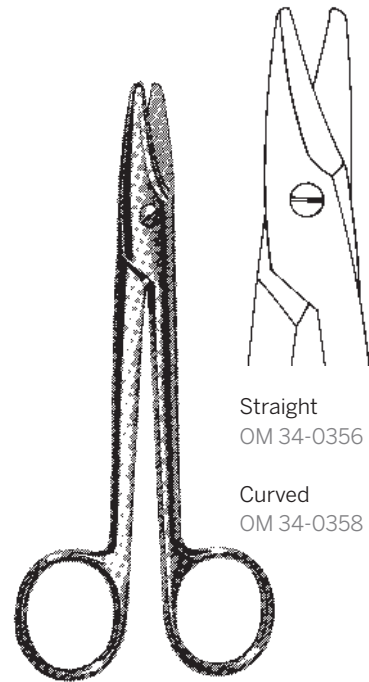

Straight
OM 34-0356

Curved
OM 34-0358

SISTRUNK SCISSORS
5 1/2" (140mm) Heavy pattern

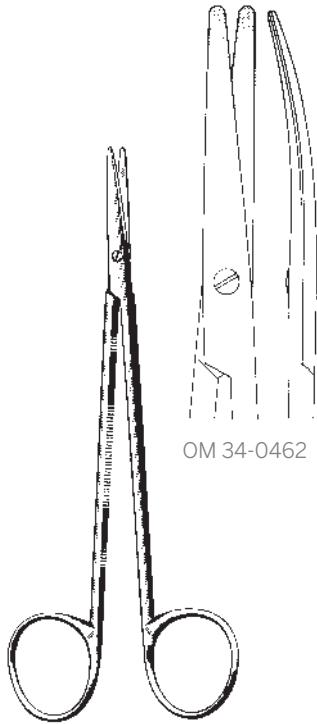

OM 34-0462

Straight

- OM 34-0436 4 1/2" (114mm)
- OM 34-0458 6" (152mm)
- OM 34-0466 7" (178mm)
- OM 34-0472 8" (203mm)
- OM 34-0476 9" (229mm)
- OM 34-0486 11" (279mm)

Curved

- OM 34-0438 4 1/2" (114mm)
- OM 34-0492 5 3/4" (146mm) delicate
- OM 34-0462 6" (152mm)
- OM 34-0470 7" (178mm)
- OM 34-0494 7" (178mm) delicate
- OM 34-0474 8" (203mm)
- OM 34-0478 9" (229mm)
- OM 34-0488 11" (279mm)

METZENBAUM SCISSORS
blunt points

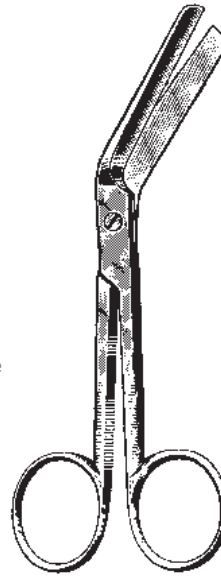

Angled sideways

- OM 34-0502 5 1/2" (140mm)
- OM 34-0504 8 1/2" (216mm)

BRAUN EPISIOTOMY SCISSORS

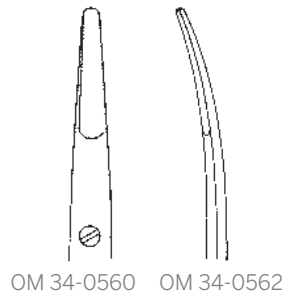
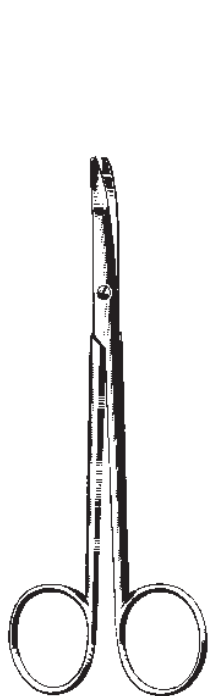

Curved

- OM 34-0560
- 5" (127mm)
- flat blunt tips

- OM 34-0562
- 7" (178mm)
- flat blunt tips

RAGNELL SCISSORS

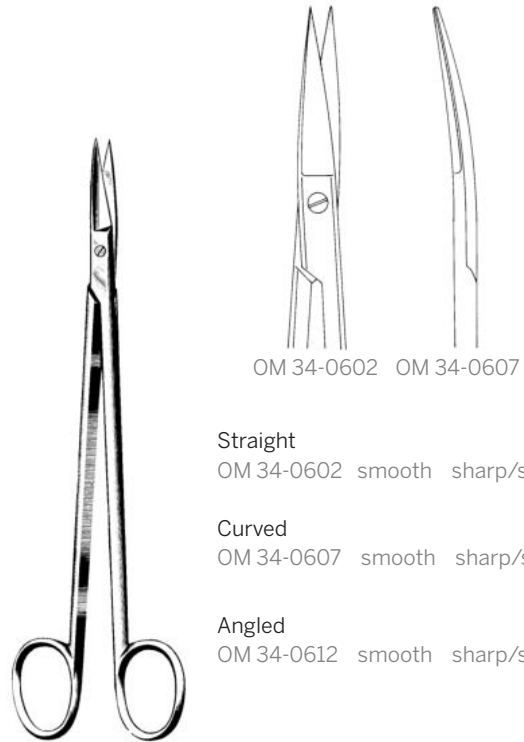

OM 34-0602 OM 34-0607

Straight

- OM 34-0602 smooth sharp/sharp

Curved

- OM 34-0607 smooth sharp/sharp

Angled

- OM 34-0612 smooth sharp/sharp

KELLY FISTULA SCISSORS
6 1/4" (159mm)

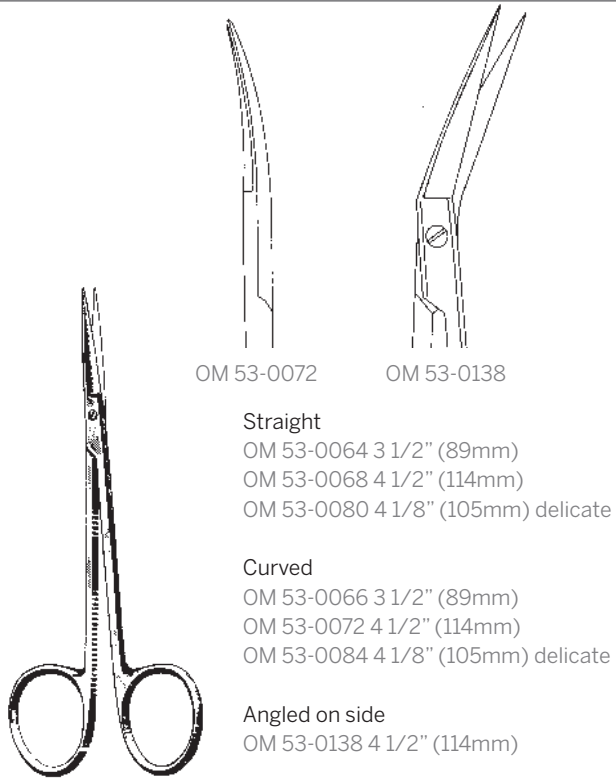

OM 53-0072

OM 53-0138

Straight

- OM 53-0064 3 1/2" (89mm)
- OM 53-0068 4 1/2" (114mm)
- OM 53-0080 4 1/8" (105mm) delicate

Curved

- OM 53-0066 3 1/2" (89mm)
- OM 53-0072 4 1/2" (114mm)
- OM 53-0084 4 1/8" (105mm) delicate

Angled on side

- OM 53-0138 4 1/2" (114mm)

IRIS SCISSORS

Sharp points

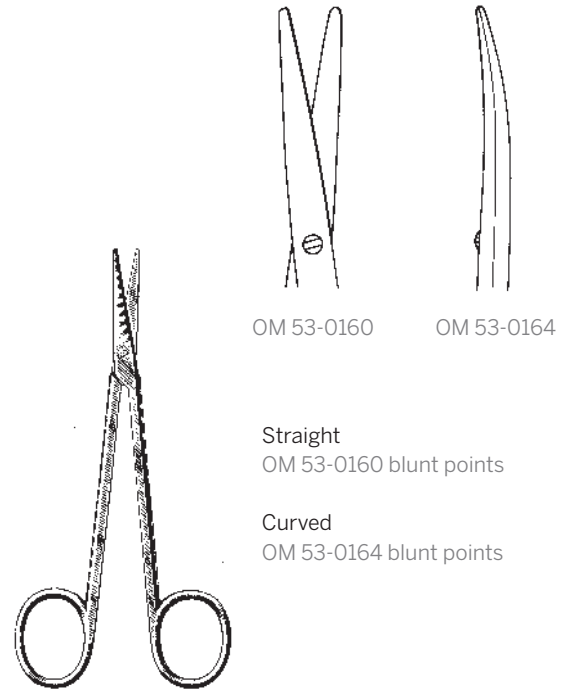

OM 53-0160

OM 53-0164

Straight

- OM 53-0160 blunt points

Curved

- OM 53-0164 blunt points

STRABISMUS SCISSORS

4" (102mm)

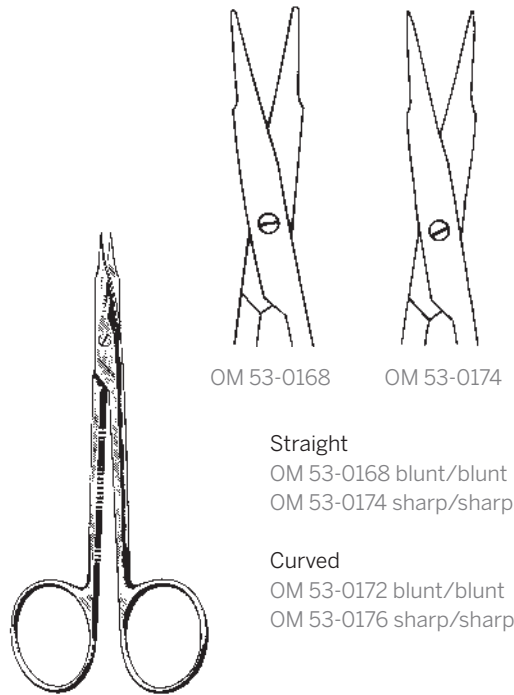

OM 53-0168

OM 53-0174

Straight

- OM 53-0168 blunt/blunt
- OM 53-0174 sharp/sharp

Curved

- OM 53-0172 blunt/blunt
- OM 53-0176 sharp/sharp

STEVENS TENOTOMY SCISSORS

4 1/4" (108mm)

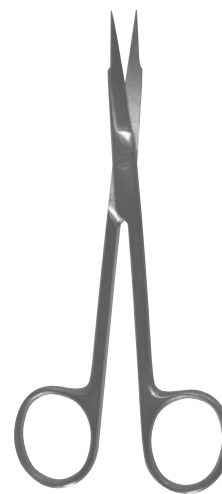

Straight

- OM 53-0265 3 3/4" (95mm)

Curved

- OM 53-0267 4" (102mm)

IRIS SCISSORS RIBBON TYPE

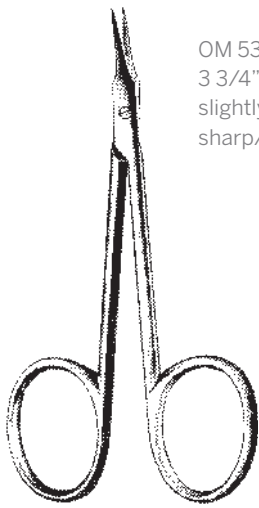

OM 53-0316
3 3/4" (95mm)
slightly curved
sharp/sharp

GRADLE SCISSORS



OM 53-0318
4" (102mm)
slightly curved
ribbon type
sharp/sharp

GRADLE SCISSORS

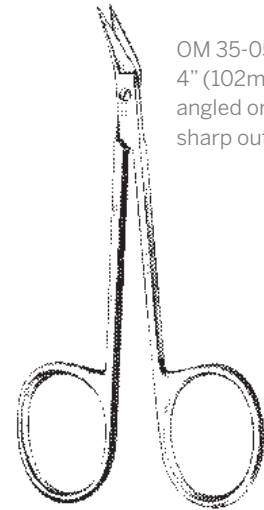

OM 35-0515
4" (102mm)
angled on flat
sharp outside edges

**BIRO DERMAL
NAEVUS SCISSORS**



OM 35-0078
4 5/8" (117.5mm)
with suture hole

OM 35-0078SC
4 5/8" (117.5mm)
with suture hole
super cut

LITTLER SCISSORS



OM 69-0106
3 1/2" (89mm)
curved stainless

NAIL SCISSORS

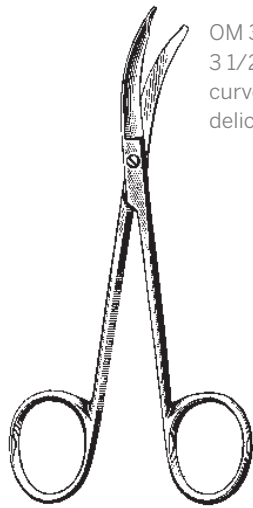

OM 35-0080
3 1/2" (89mm)
curved on side
delicate

**SHORTBENT STITCH
SCISSORS**



Straight
OM 35-0068
3 1/2" (89mm)
delicate

**SPENCER STITCH
SCISSORS**

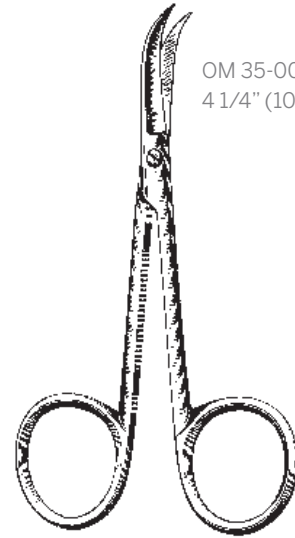

OM 35-0084
4 1/4" (108mm)

**HILL STITCH
SCISSORS**



OM 35-0104
4 3/4" (121mm)
curved on side

NORTHBENT STITCH SCISSORS

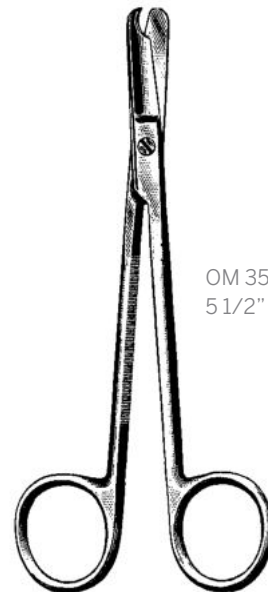

OM 35-0120
5 1/2" (140mm)

LITTAUER STITCH SCISSORS

Note: Tungsten carbide (TC) is one of the hardest alloys made today. Our TC scissors have tungsten carbide firmly bonded to both cutting edges. We guarantee that they will stay sharp for at least three years. The finger rings are gold plated for easy identification.

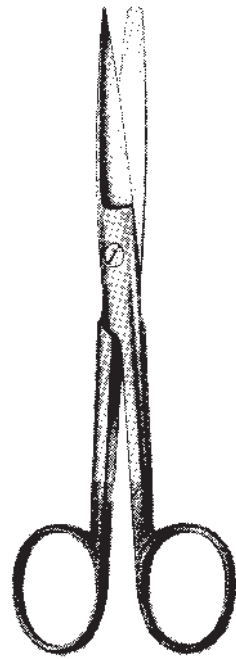

TC OPERATING SCISSORS

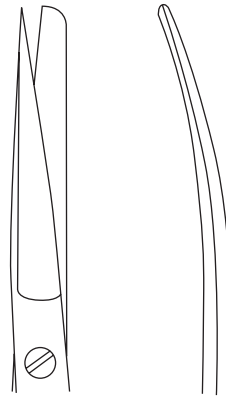

OM 35-0600 OM 35-0610

Straight
OM 35-0600
5 1/2" (140mm)
sharp/blunt

Curved
OM 35-0610
5 1/2" (140mm)
sharp/blunt



TC MAYO SCISSORS
Beveled blades

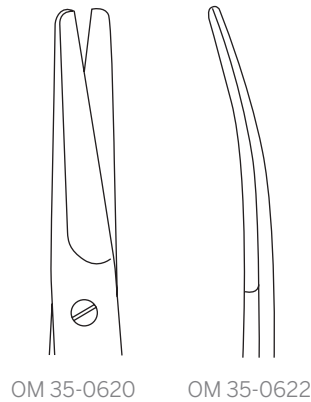

OM 35-0620 OM 35-0622

Straight
OM 35-0620 5 1/2" (140mm)
OM 35-0624 6 3/4" (171mm)
OM 35-0628 9" (229mm)

Curved
OM 35-0622 5 1/2" (140mm)
OM 35-0626 6 3/4" (171mm)
OM 35-0630 9" (229mm)



TC METZENBAUM SCISSORS
Blunt points



OM 35-0646

Straight
OM 35-0640 6" (152mm)
OM 35-0644 7" (178mm)
OM 35-0652 9" (229mm)

Curved
OM 35-0642 6" (152mm)
OM 35-0646 7" (178mm)
OM 35-0654 9" (229mm)

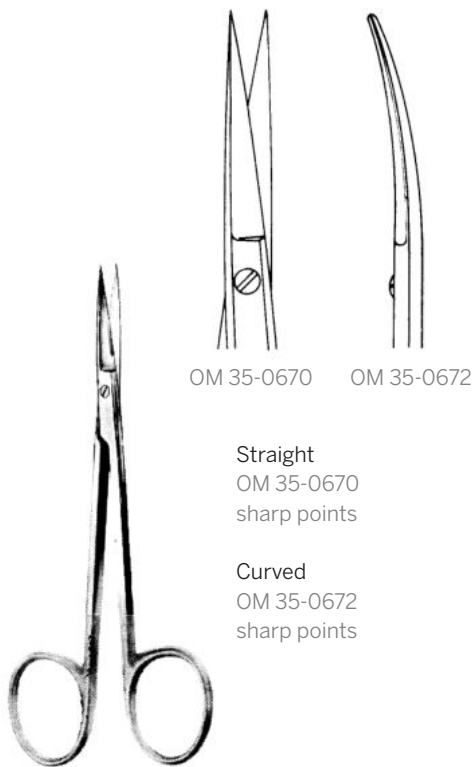

OM 35-0670 OM 35-0672

Straight
OM 35-0670
sharp points

Curved
OM 35-0672
sharp points

TC IRIS SCISSORS
4 1/2" (114mm)

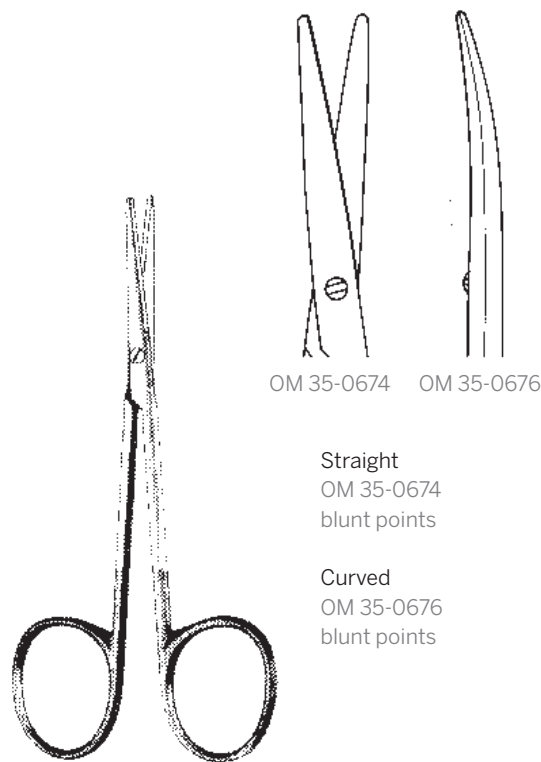

OM 35-0674 OM 35-0676

Straight
OM 35-0674
blunt points

Curved
OM 35-0676
blunt points

TC STRABISMUS SCISSORS
4 1/2" (114mm)

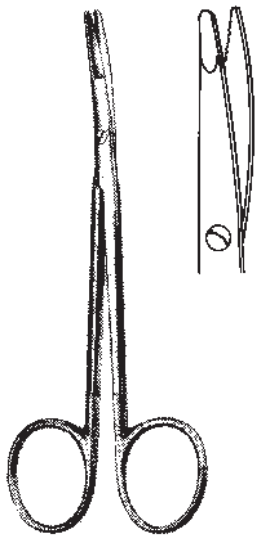

Curved
OM 35-0510
4 1/2" (114mm)
flat tips,
one serrated and
one carbide blade

BLEPHAROPLASTY SCISSORS

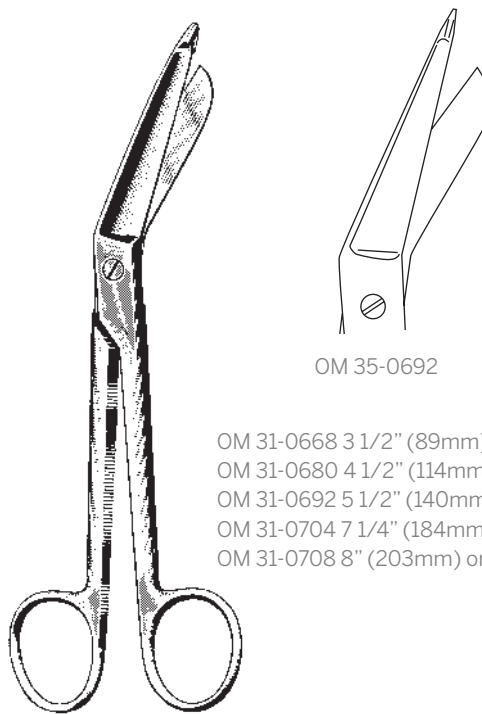

OM 35-0692

OM 31-0668 3 1/2" (89mm)
OM 31-0680 4 1/2" (114mm)
OM 31-0692 5 1/2" (140mm)
OM 31-0704 7 1/4" (184mm)
OM 31-0708 8" (203mm) one large finger ring

LISTER BANDAGE SCISSORS

The delicate offset shanks provide better leverage. The fine knob slides easily under finger and toe bandages.

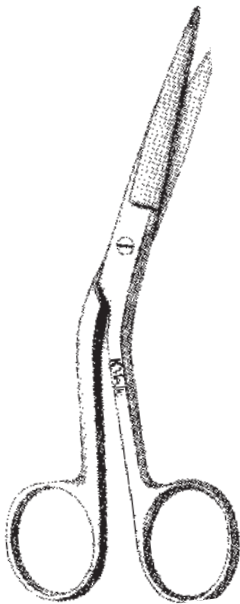

OM 31-0792
5 1/2" (140mm)
shanks angled on side
one serrated blade

HI-LEVEL BANDAGE SCISSORS

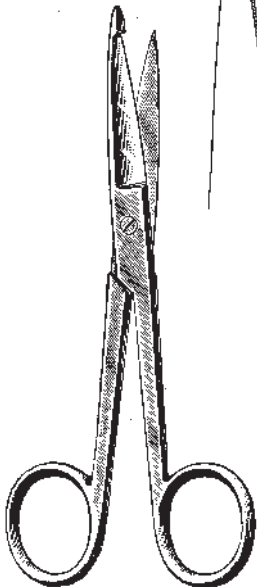

Straight
OM 31-0804
5 1/2" (140mm)
one serrated blade

KNOWLES BANDAGE SCISSORS



For finger and toe bandages.

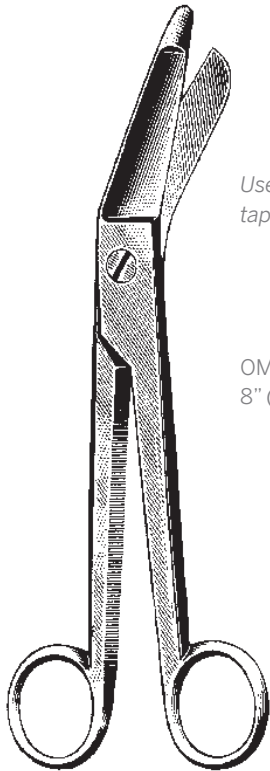

Useful for cutting tape and bandages.

OM 46-0060
8" (203mm)

ESMARCH SHEARS

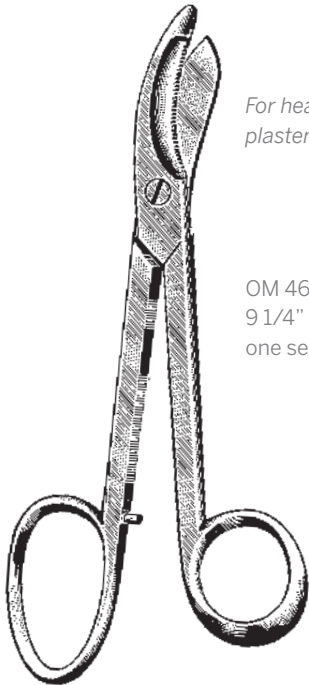

For heavier plaster.

OM 46-0090
9 1/4" (235mm)
one serrated blade

BRUNS SHEARS

For light plaster and cloth.

With autoclavable plastic finger rings.

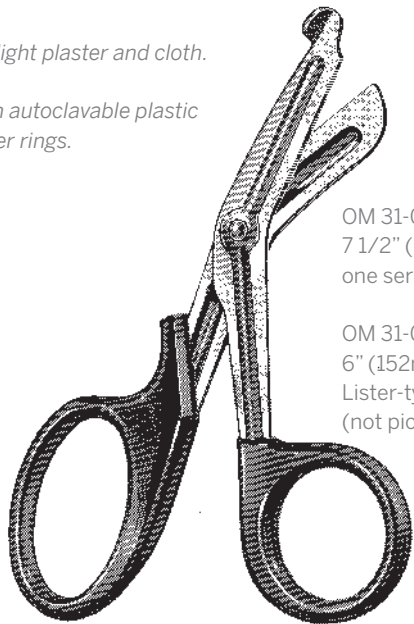

OM 31-0830
7 1/2" (191mm)
one serrated blade

OM 31-0832
6" (152mm)
Lister-type
(not pictured)

UTILITY SCISSORS

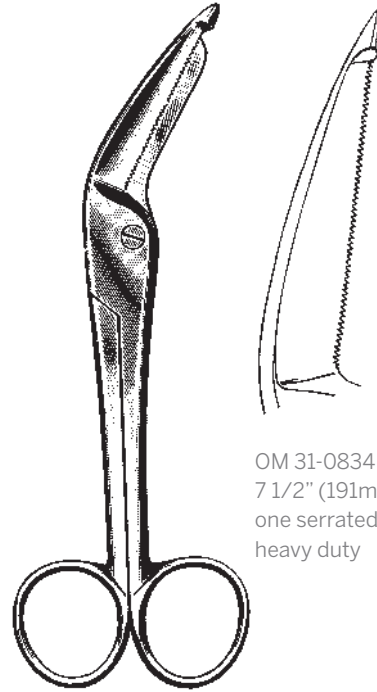

OM 31-0834
7 1/2" (191mm)
one serrated blade
heavy duty

HERCULES SCISSORS



Effective for cloth or cotton wadding.

OM 31-0836
8" (203mm)
with wire cutting notch
one serrated blade

ORTHOMED UTILITY SHEARS



OM MX 5-700
Pink handle

OM MX 5-702
Blue handle

NURSES SCISSORS
5 1/2" (140mm)

Notch for cutting cerclage wire up to 1mm.

OM 35-0198

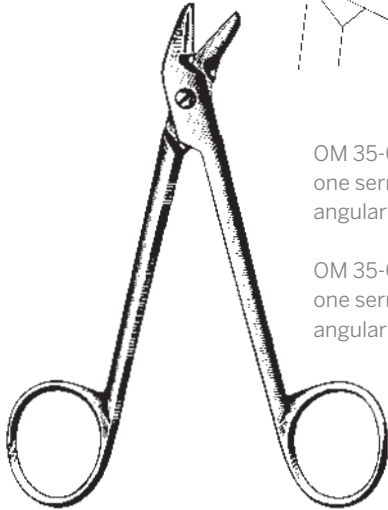
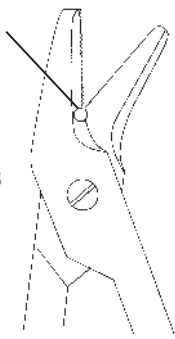

OM 35-0198
one serrated blade
angular

OM 35-0200
one serrated blade
angular carbide

WIRE CUTTING SCISSORS
4 3/4" (121mm)



OM 35-0194

Straight
OM 35-0168
smooth

OM 35-0170
one serrated blade

Curved
OM 35-0192
smooth

OM 35-0194
one serrated blade

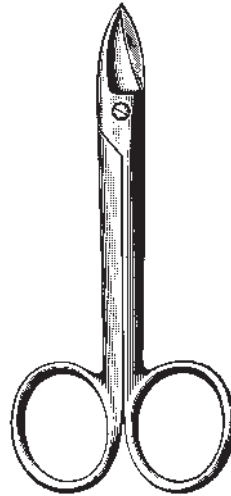

WIRE CUTTING SCISSORS
4" (102mm)



OM 36-0063

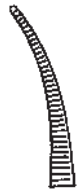

OM 36-0067

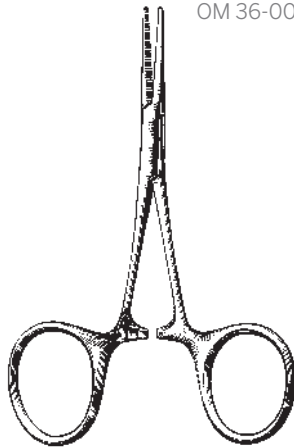

Straight
OM 36-0063

Curved
OM 36-0067

HARTMANN MOSQUITO FORCEPS
3 1/2" (89mm)



OM 36-0164



OM 36-0165



Straight
OM 36-0164

Curved
OM 36-0165

MICRO MOSQUITO FORCEPS
5" (127mm) Extremely fine tips

HEMOSTATIC FORCEPS

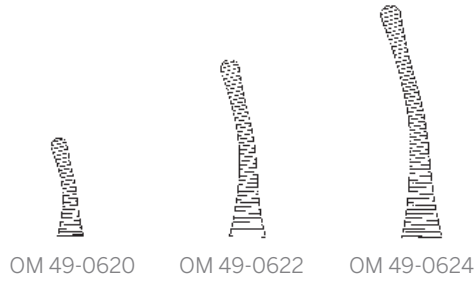

OM 49-0620 OM 49-0622 OM 49-0624



- Straight**
- OM 49-0602 1 1/2" (38mm)
 - OM 49-0604 2" (51mm)
 - OM 49-0606 2 1/2" (64mm)
 - OM 49-0608 3" (76mm)
 - OM 49-0610 3 1/2" (89mm)
- Curved**
- OM 49-0618 1 1/2" (38mm)
 - OM 49-0620 2" (51mm)
 - OM 49-0622 2 1/2" (64mm)
 - OM 49-0624 3" (76mm)
 - OM 49-0626 3 1/2" (89mm)

JOHNS HOPKINS BULLDOG CLAMPS

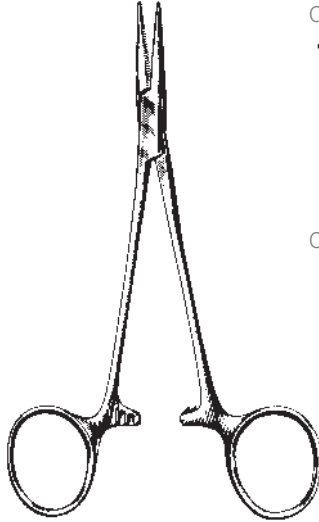

HALSTED MOSQUITO FORCEPS 5" (127mm)

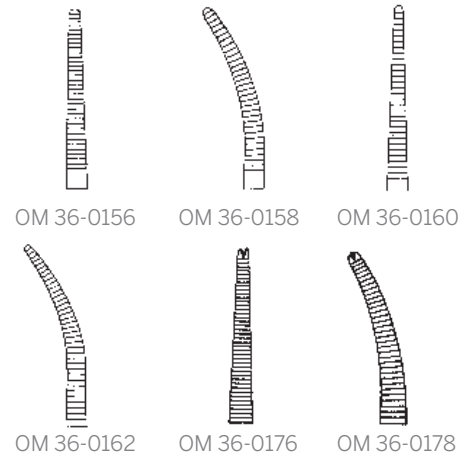

OM 36-0156 OM 36-0158 OM 36-0160
OM 36-0162 OM 36-0176 OM 36-0178

- Straight**
- OM 36-0156
 - OM 36-0160 delicate
 - OM 36-0076 1x2 teeth
- Curved**
- OM 36-0158
 - OM 36-0162 delicate
 - OM 36-0078 1x2 teeth

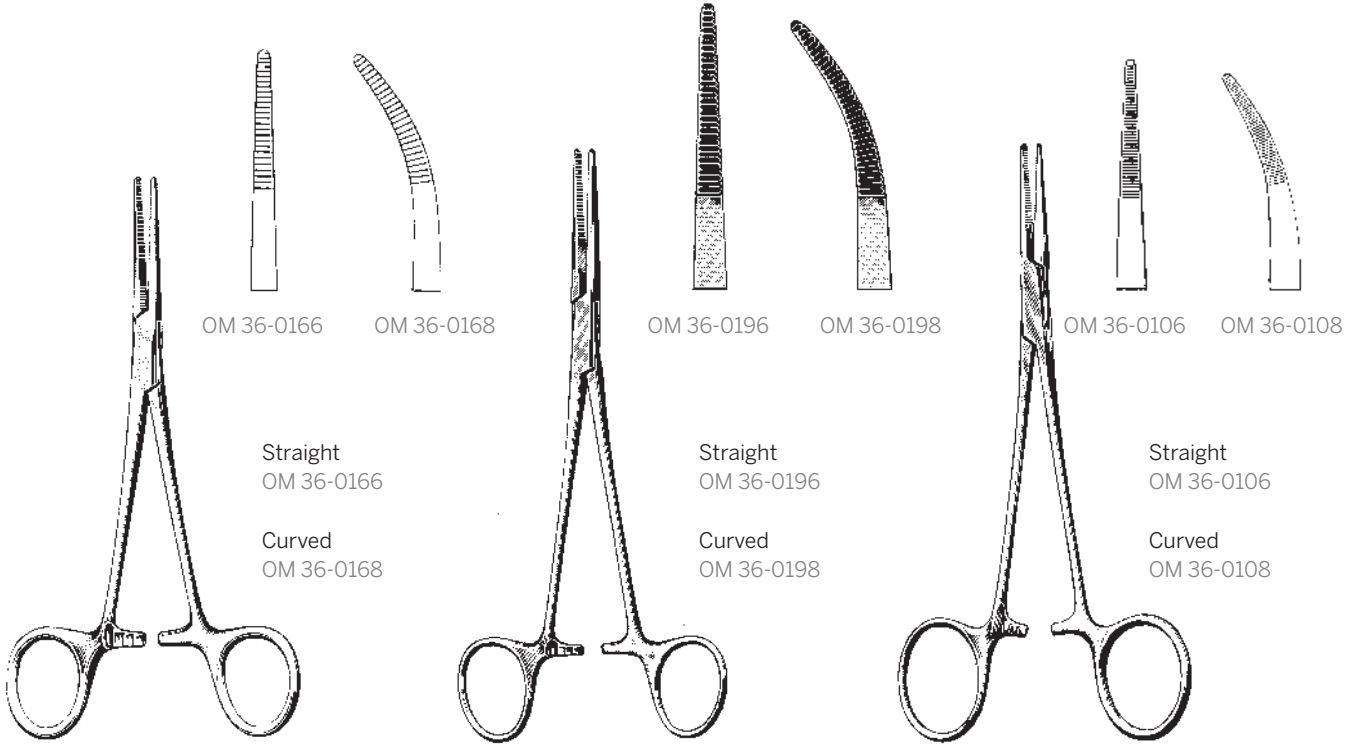

OM 36-0166 OM 36-0168 OM 36-0196 OM 36-0198 OM 36-0106 OM 36-0108

- Straight**
- OM 36-0166
- Curved**
- OM 36-0168

- Straight**
- OM 36-0196
- Curved**
- OM 36-0198



- Straight**
- OM 36-0106
- Curved**
- OM 36-0108

KELLY FORCEPS 5 1/2" (140mm)

RANKIN-KELLY FORCEPS 6 1/4" (159mm)

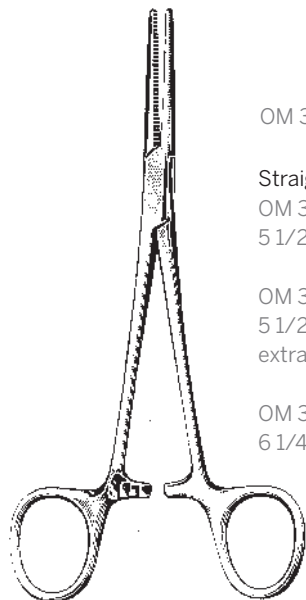

PROVIDENCE HOSPITAL FORCEPS 5 1/2" (140mm)



- | | |
|---|---|
|  |  |
| OM 36-0176 | OM 36-0178 |
| Straight | Curved |
| OM 36-0176 | OM 36-0178 |
| 5 1/2" (140mm) | 5 1/2" (140mm) |
| OM 36-0180 | OM 36-0182 |
| 5 1/2" (140mm) | 5 1/2" (140mm) |
| extra delicate | extra delicate |
| OM 36-0186 | OM 36-0188 |
| 6 1/4" (159mm) | 6 1/4" (159mm) |

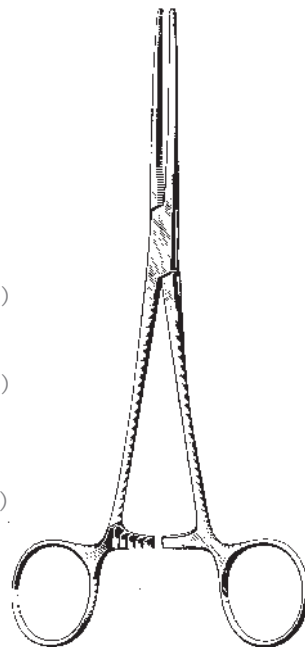

CRILE FORCEPS

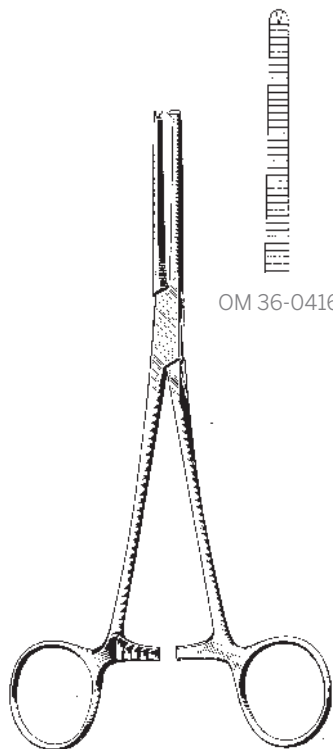

- | | |
|---|---|
|  |  |
| OM 36-0306 | OM 36-0308 |
| Straight | |
| OM 36-0306 | 5 1/2" (140mm) |
| OM 36-0316 | 6 1/4" (159mm) |
| OM 36-0326 | 7 1/4" (184mm) |
| OM 36-0336 | 8" (203mm) |
| OM 36-0346 | 9" (229mm) |
| OM 36-0356 | 10" (254mm) |
| OM 36-0360 | 12" (305mm) |
| Curved | |
| OM 36-0308 | 1/2" (140mm) |
| OM 36-0318 | 6 1/4" (159mm) |
| OM 36-0328 | 7 1/4" (184mm) |
| OM 36-0338 | 8" (203mm) |
| OM 36-0348 | 9" (229mm) |
| OM 36-0358 | 10" (254mm) |
| OM 36-0362 | 12" (305mm) |

ROCHESTER PEAN FORCEPS



- | | |
|---|---|
|  |  |
| OM 36-0416 | OM 36-0418 |
| Straight | Curved |
| OM 36-0406 | OM 36-0408 |
| 5 1/2" (140mm) | 5 1/2" (140mm) |
| OM 36-0416 | OM 36-0418 |
| 6 1/4" (159mm) | 6 1/4" (159mm) |
| OM 36-0426 | OM 36-0428 |
| 7 1/4" (184mm) | 7 1/4" (184mm) |
| OM 36-0436 | OM 36-0438 |
| 8" (203mm) | 8" (203mm) |
| OM 36-0446 | OM 36-0448 |
| 9" (229mm) | 9" (229mm) |
| OM 36-0456 | OM 36-0458 |
| 10" (254mm) | 10" (254mm) |

ROCHESTER-OSHSNER FORCEPS
1 x 2 Teeth



- | |
|---|
|  |
| OM 36-0557 |
| OM 36-0566 |
| OM 36-0557 |
| 5 1/4" (133mm) |
| delicate |
| OM 36-0562 |
| 6 1/4" (159mm) |
| OM 36-0564 |
| 7 1/4" (184mm) |
| OM 36-0566 |
| 9" (229mm) |

MIXTER FORCEPS
Fully curved



OM 36-0570
7" (171mm)
serrated

GEMINI MIXTER FORCEPS

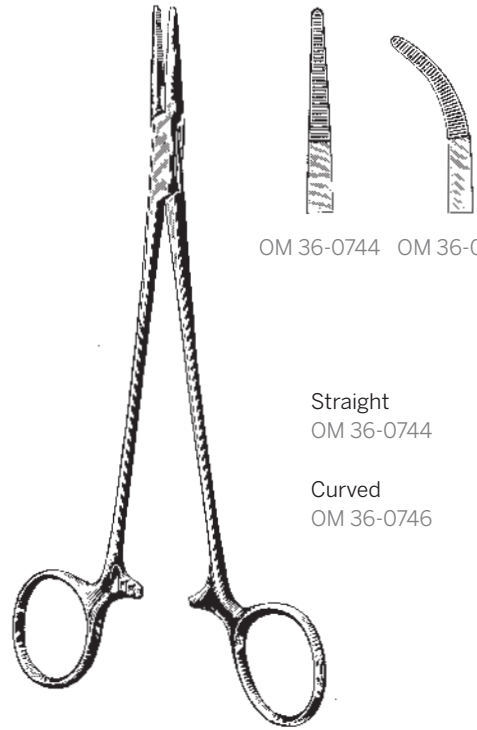

OM 36-0744 OM 36-0746

Straight
OM 36-0744

Curved
OM 36-0746

ADSON HEMOSTATIC FORCEPS

7 1/4" (184mm)

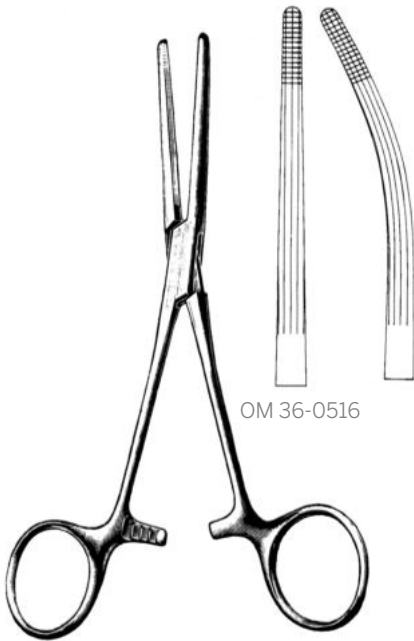

OM 36-0518

Straight
OM 36-0516
6 1/4" (159mm)

OM 36-0516

OM 36-0536
8" (203mm)

Curved
OM 36-0518
6 1/4" (159mm)

OM 36-0538
8" (203mm)

ROCHESTER-CARMALT FORCEPS



OM 36-0818

Straight
OM 36-0816
6 1/2" (165mm)

OM 36-0826
7 1/2" (191mm)

Curved
OM 36-0818
6 1/2" (165mm)

OM 36-0828
7 1/2" (191mm)

FERGUSON ANGIOTRIBE FORCEPS

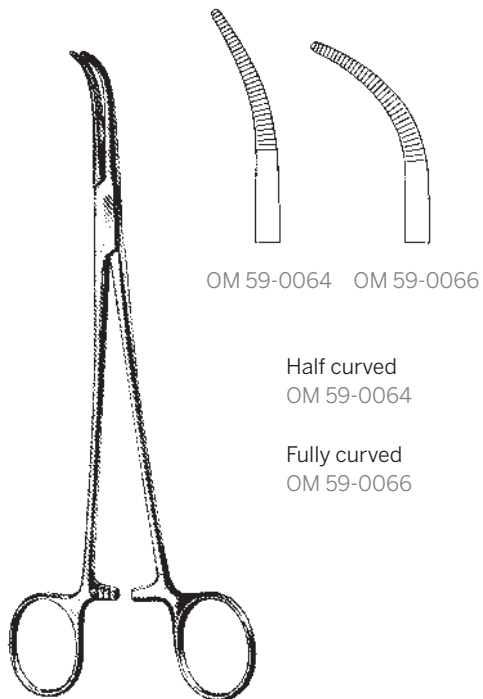

OM 59-0064 OM 59-0066

Half curved
OM 59-0064

Fully curved
OM 59-0066

SCHNIDT FORCEPS

7 1/2" (191mm)

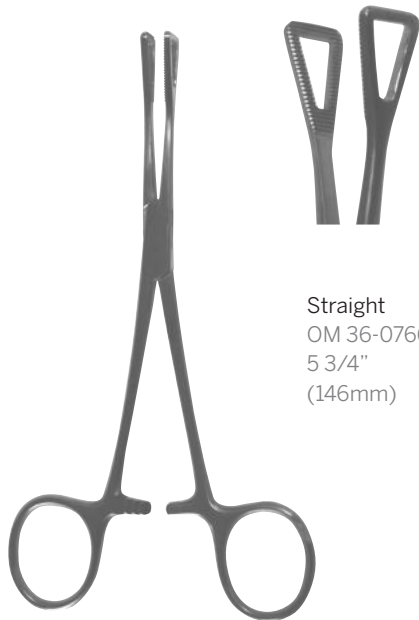

Straight
OM 36-0766
5 3/4"
(146mm)

PENNINGTON FORCEPS

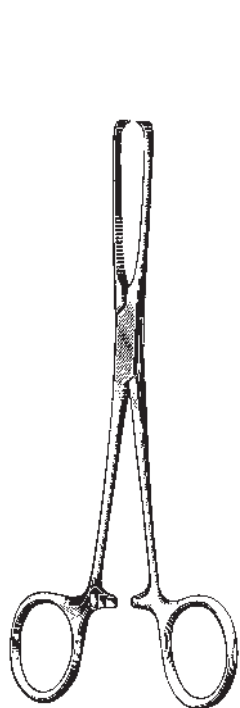

- 

OM 43-0105

OM 43-0105 4 3/4" (121mm)
4x5 teeth delicate

OM 43-0107 5 3/4" (146mm)
4x5 teeth delicate

OM 43-0110 6" (152mm)
3x4 teeth standard

OM 43-0112 6" (152mm)
4x5 teeth standard

OM 43-0116 6" (152mm)
5x6 teeth standard

OM 49-0628 10"
5x6 teeth standard

OM 49-0629 12"
5x6 teeth standard

ALLIS TISSUE FORCEPS



OM 43-0124
7 1/2" (191mm)
5x6 teeth

ALLIS TISSUE FORCEPS

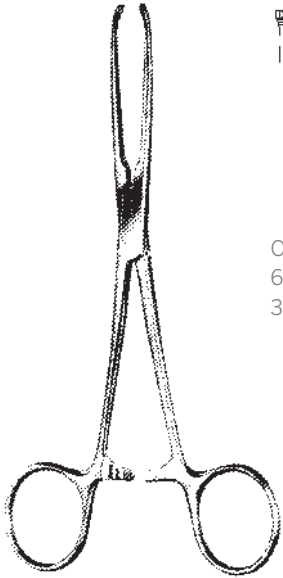

OM 43-0168
6" (152mm)
3x4 teeth

ALLIS-JUDD TISSUE FORCEPS



OM 43-0310

OM 43-0310
6 1/4" (159mm)

OM 43-0324
8" (203mm)

OM 43-0326
9 1/2" (241mm)

BABCOCK FORCEPS

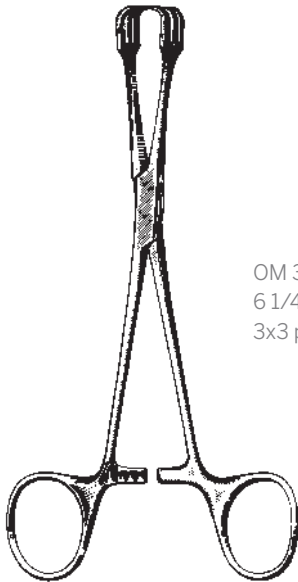

OM 36-0696
6 1/4" (159mm)
3x3 prongs

LAHEY VULSELLUM FORCEPS

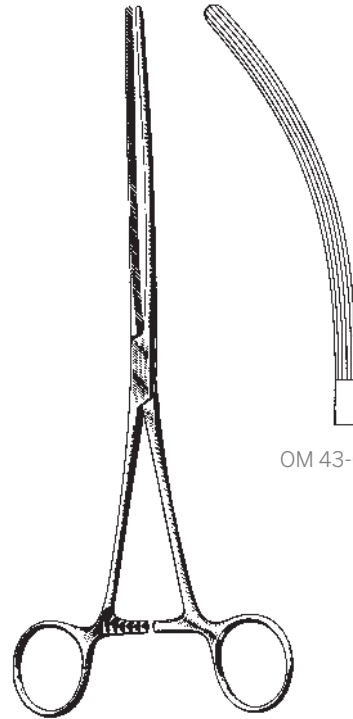

OM 43-0524

Straight
OM 43-0520

Curved
OM 43-0524

DOYEN CLAMP
9" (229mm) Longitudinal serrations

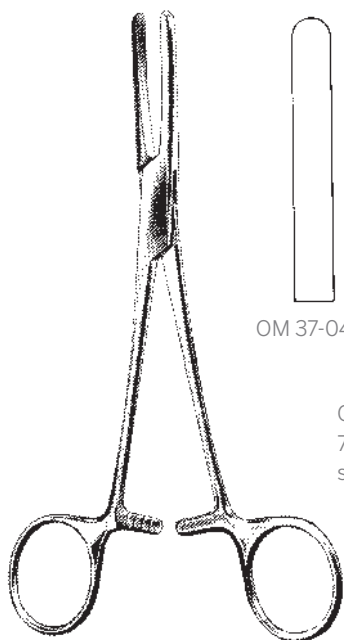

OM 37-0444

OM 37-0444
7" (178mm)
smooth

**PRESBYTERIAN TUBE
OCCLUDING FORCEPS**

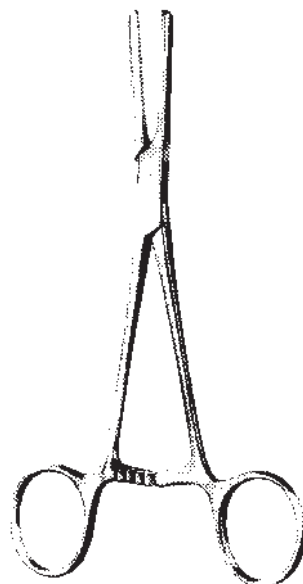

OM 37-0448

OM 37-0448
5 1/2" (140mm)

OM 37-0450
7 1/4" (184mm)

OM 37-0452
8" (203mm)

VORSE TUBE OCCLUDING FORCEPS
Serrated



OM 37-0453

OM 37-0453 5 1/2" (140mm)
OM 37-0454 7 1/4" (184mm)
OM 37-0455 8" (203mm)

VORSE TUBE OCCLUDING FORCEPS
Serrated, with guard

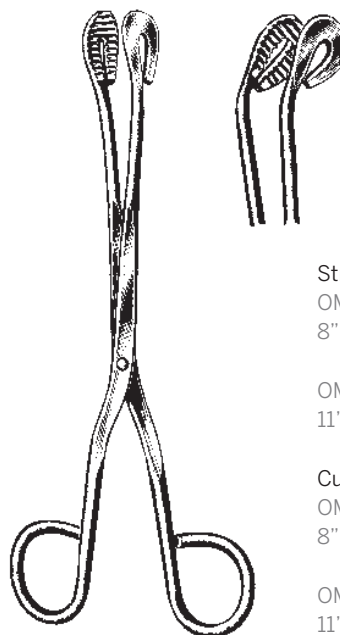

Straight
OM 39-0644
8" (203mm)

OM 39-0646
11" (279mm)

Curved
OM 39-0648
8" (203mm)

OM 39-0650
11" (279mm)

**UTILITY AND
STERILIZER FORCEPS**

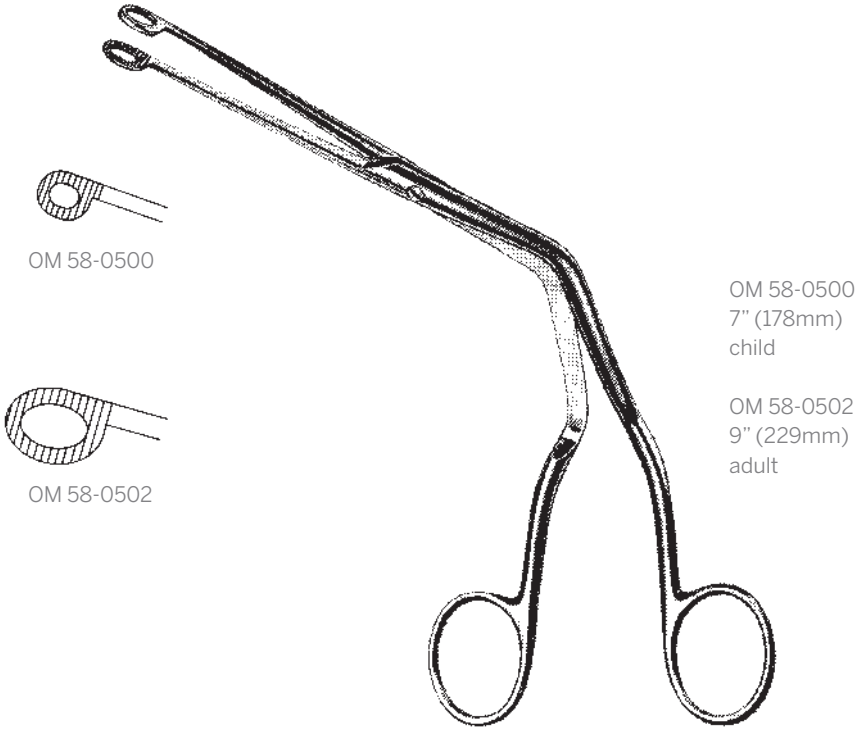

MAGILL ENDOTRACHEAL CATHETER INTRODUCING FORCEPS

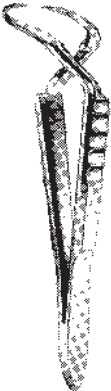

OM 37-0470
2 1/2" (64mm)

OM 37-0478
3 1/4" (83mm)

JONES TOWEL FORCEPS



OM 37-0458
3 1/2" (89mm)

OM 37-0462
5 1/4" (133mm)

BACKHAUS TOWEL FORCEPS

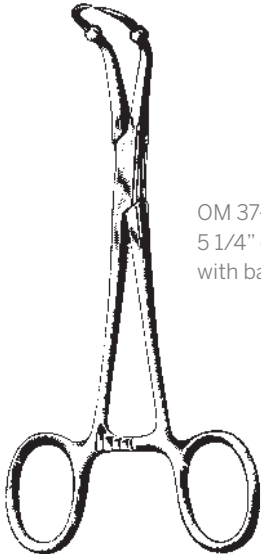

OM 37-0464
5 1/4" (133mm)
with ball stops

BACKHAUS-ROEDER TOWEL CLAMP

TOWEL AND SPONGE FORCEPS/DRESSING AND TISSUE FORCEPS



OM 47-0466

OM 37-0466
4" (102mm)
non-perforating

OM 37-0468
5 1/4" (133mm)
non-perforating

**LORNA (EDNA)
TOWEL CLAMP**

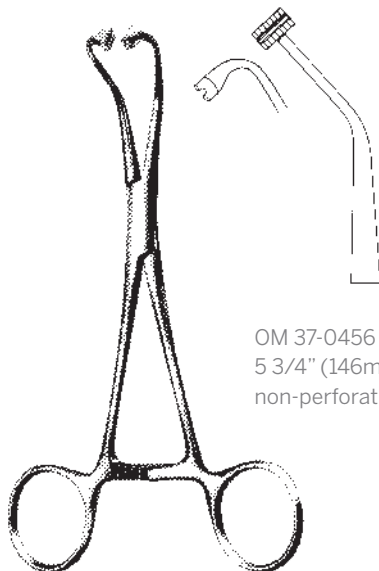

OM 37-0456
5 3/4" (146mm)
non-perforating

PEERS TOWEL CLAMP

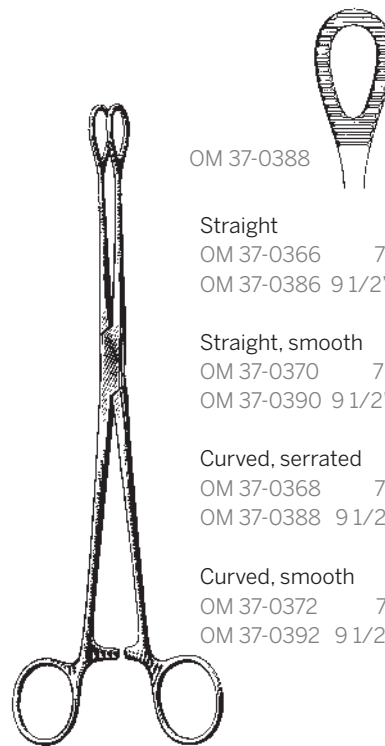

OM 37-0388

Straight
OM 37-0366 7" (178mm)
OM 37-0386 9 1/2" (241mm)

Straight, smooth
OM 37-0370 7" (178mm)
OM 37-0390 9 1/2" (241mm)

Curved, serrated
OM 37-0368 7" (178mm)
OM 37-0388 9 1/2" (241mm)

Curved, smooth
OM 37-0372 7" (178mm)
OM 37-0392 9 1/2" (241mm)

**FOERSTER SPONGE
FORCEPS**

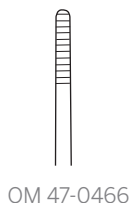

OM 47-0466

OM 38-0076 4 1/2" (114mm)
OM 38-0080 5" (127mm)
OM 38-0084 5 1/2" (140mm)
OM 38-0088 6" (152mm)
OM 38-0094 8" (203mm)
OM 38-0100 10" (254mm)
OM 38-0106 12" (305mm)

DRESSING FORCEPS
Serrated

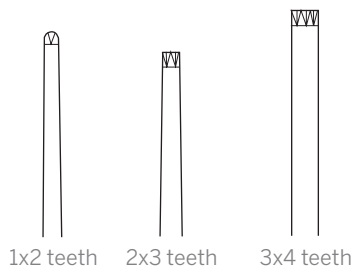

1x2 teeth
OM 38-0264 4 1/2" (114mm)
OM 38-0268 5" (127mm)
OM 38-0272 5 1/2" (140mm)
OM 38-0276 6" (152mm)
OM 38-0280 8" (203mm)
OM 38-0286 10" (254mm)
OM 38-0290 12" (305mm)

2x3 teeth
OM 38-0292 5" (127mm)
OM 38-0296 5 1/2" (140mm)

3x4 teeth
OM 38-0304 5 1/2" (140mm)

TISSUE FORCEPS

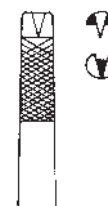

1x2 teeth
OM 38-0322

2x3 teeth
OM 38-0324

FERRIS-SMITH TISSUE FORCEPS
7" (178mm) with platform

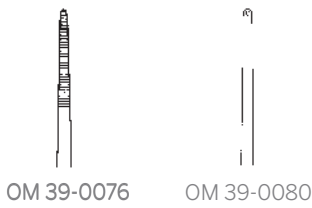
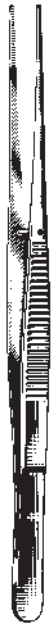

Serrated
 OM 39-0076 5" (127mm)
 OM 39-0086 6" (152mm)

1x2 teeth
 OM 39-0080 5" (127mm)
 OM 39-0088 6" (152mm)

SEMKEN FORCEPS

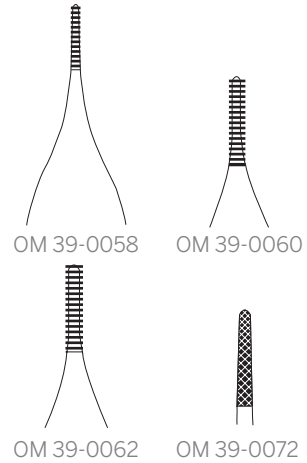

OM 39-0058 micro tip
 OM 39-0060 delicate tip
 OM 39-0062 standard tip
 OM 39-0072 carbide tip

ADSON DRESSING FORCEPS

4 3/4" (121mm) serrated

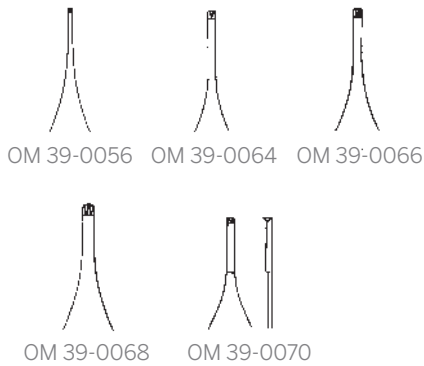
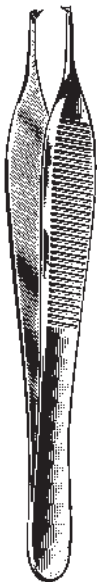

1x2 teeth
 OM 39-0056 micro tip
 OM 39-0063 serrated tip
 OM 39-0064 delicate tip
 OM 39-0066 standard tip
 OM 39-0070 delicate, with tying platform
 OM 39-0071 carbide tip

2x3 teeth
 OM 39-0068

ADSON TISSUE FORCEPS

4 3/4" (121mm)

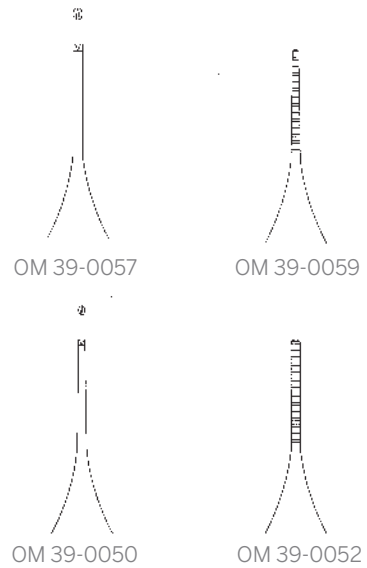

OM 39-0057 micro 1x2 teeth
 OM 39-0059 micro serrated
 OM 39-0050 1x2 teeth
 OM 39-0052 serrated

ADSON DRESSING AND TISSUE FORCEPS

6" (152mm)

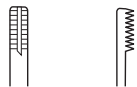

OM 39-0092
4 3/4" (121mm)
9x9 teeth
side grasping

ADSON BROWN TISSUE FORCEPS

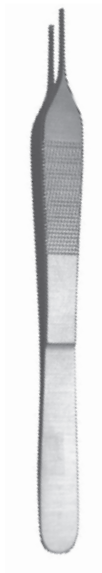

OM 39-0098
7" (178mm) 3mm
2x3 teeth

OM 39-0099
7" (178mm) 3mm
2x3 teeth
with carbide inserts

ADSON TISSUE FORCEPS



OM 39-0055

ADSON TISSUE FORCEP
TC 1S2 Teeth SERR. 6"



OM 39-0136

OM 39-0128 4 1/2" (114mm)
OM 39-0132 5" (127mm)
OM 39-0136 5 1/2" (140mm)
OM 39-0140 6" (152mm)

DRESSING FORCEPS
Serrated with fluted handles



OM 39-0310 4 1/2" (114mm)
OM 39-0314 5" (127mm)
OM 39-0318 5 1/2" (140mm)
OM 39-0322 6" (152mm)

TISSUE FORCEPS
1x2 teeth with fluted handles

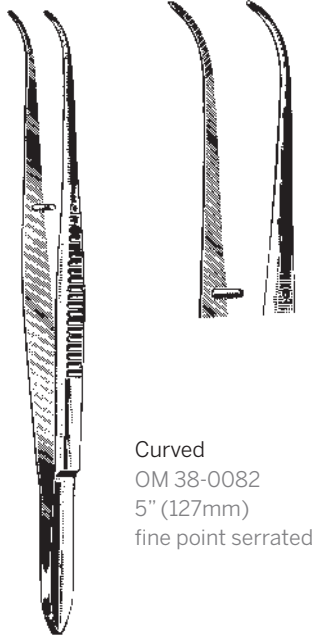

Curved
OM 38-0082
5" (127mm)
fine point serrated

DRESSING FORCEPS



OM 39-0192

OM 39-0192 6" (152mm)
OM 39-0196 8" (203mm)
OM 39-0197 9" (229mm)
OM 39-0198 10" (254mm)

**RUSSIAN
TISSUE FORCEPS**

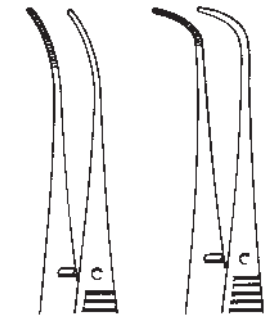

OM 53-0372

OM 53-0374

OM 53-0368 4" (102mm)
straight

OM 53-0372 4" (102mm)
half curved

OM 53-0374 4" (102mm)
fully curved

EYE DRESSING FORCEPS
4" (102mm) serrated

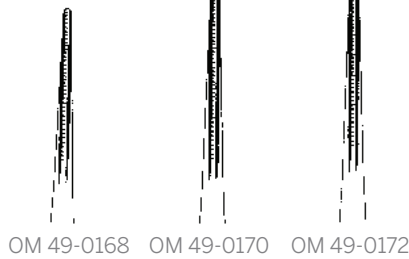

OM 49-0168 6 1/4" (159mm) 1.5mm
OM 49-0170 8" (203mm) 1.5mm
OM 49-0172 9 1/4" (235mm) 1.5mm
OM 49-0180 6 1/4" (159mm) 2.0mm
OM 49-0182 8" (203mm) 2.0mm
OM 49-0184 9 1/4" (235mm) 2.0mm
OM 49-0210 6 1/4" (159mm) 3.5mm
OM 49-0212 8" (203mm) 3.5mm
OM 49-0216 9 1/4" (235mm) 3.5mm

ADSON TISSUE FORCEPS

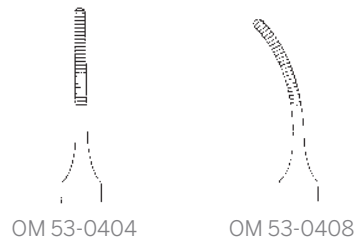

OM 53-0404

OM 53-0408

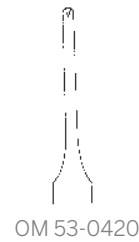

OM 53-0420

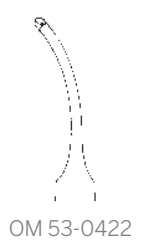

OM 53-0422

OM 53-0404 straight serrated
OM 53-0408 curved serrated
OM 53-0420 straight 1x2 teeth
OM 53-0422 curved 1x2 teeth

ADSON DRESSING AND TISSUE FORCEPS
6" (152mm)

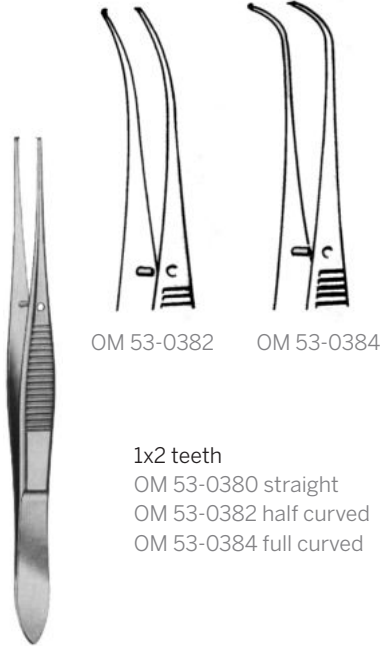

OM 53-0382 OM 53-0384

1x2 teeth
 OM 53-0380 straight
 OM 53-0382 half curved
 OM 53-0384 full curved

IRIS FORCEPS

4" (102mm)



Extra narrow
 OM 38-0166

DRESSING FORCEPS

5 1/2" (140mm)



1x2 teeth delicate
 OM 38-0180 straight
 OM 38-0181 curved
 OM 38-0182 straight TC

GERALD DRESSING FORCEPS

6 3/4" (171mm)

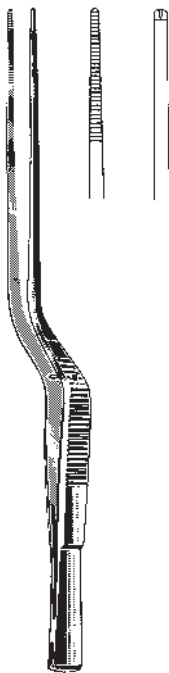

OM 38-0186 1x2 teeth
 OM 38-0184 serrated

CUSHING BAYONET TISSUE FORCEPS

7 1/4" (184mm)



OM 39-0074
 8 1/4" (210mm)
 straight with serrated tips

ADSON BAYONET FORCEPS

8 1/4" (210mm)

JEWELERS FORCEPS/SPLINTER FORCEPS



OM 39-0450
#3
4 3/4" (121mm)
narrow fine



OM 39-0451
#3C
4 3/8" (111mm)
narrow fine



OM 39-0452
#4
4 3/8" (111mm)
fine



OM 39-0453
#5
4 3/8" (111mm)
extra fine



OM 39-0455
#6
4 1/2" (114mm)
angled pickup



OM 39-0456
#7
4 1/2" (114mm)
curved fine

SWISS JEWELERS STYLE FORCEPS

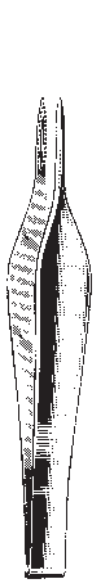

OM 39-0386

OM 39-0386
3 1/4" (83mm)

OM 39-0390
4 1/2" (114mm)



OM 39-0366

OM 39-0364
3 1/2" (89mm)

OM 39-0366
4 1/2" (114mm)



OM 39-0410

Straight
OM 39-0410

Curved
OM 39-0412



OM 39-0412

FEILCHENFELD FORCEPS

Serrated

PLAIN SPLINTER FORCEPS

Serrated

CARMALT SPLINTER FORCEPS

4 1/4" (108mm) Serrated

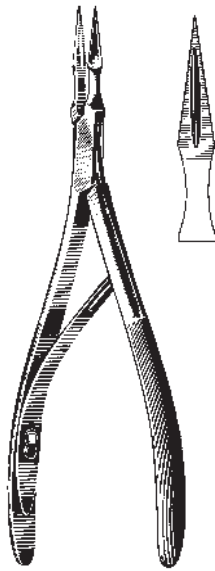

OM 39-0478
6" (152mm)
serrated

VIRTUS SPLINTER FORCEPS



OM 39-0534
5" (127mm)
trocar in reversible handle

OM 39-0536
trocar point only

VANGUARD SPLINTER LIBERATOR

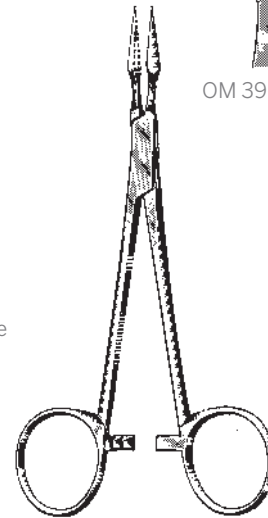

OM 39-0509 OM 39-0511

OM 39-0509
5 1/2" (140mm)
straight

OM 39-0511
5 1/4" (133mm)
45 degree angled

OM 39-0513
5 1/2" (140mm)
90 degree angled

WILLIAMS SPLINTER FORCEPS
Serrated

Note: Our carbide needle holders have TC inserts firmly bonded to the inside of both jaws. We guarantee them for three years. The surface profiles of the inserts have been precision milled to provide the surgeon with a firm, non-slip grip on the needle. Because the carbide is harder than the steel needles, carbide needle holders last much longer than ordinary ones. The finger rings are gold plated for easy identification.



OM 41-0064

OM 41-0066

OM 41-0064
smooth

OM 41-0065
smooth carbide

OM 41-0066
serrated

OM 41-0067
serrated carbide

HALSEY NEEDLE HOLDER
5" (127mm) Serrated



OM 41-0164

OM 41-0166

OM 41-0162
5" (127mm)
serrated

OM 41-0164
5 3/4" (146mm)
serrated

OM 41-0166
5 1/2" (140mm)
serrated carbide

HEGAR BAUMGARTNER NEEDLE HOLDER

NEEDLE HOLDER

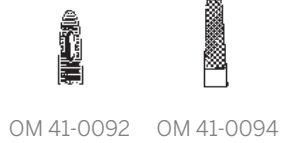
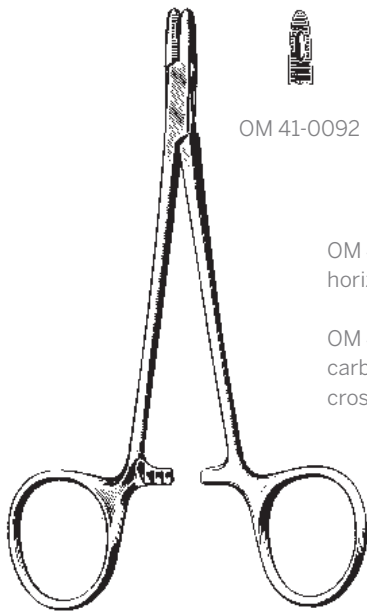

OM 41-0092
horizontal serrations

OM 41-0094
carbide
cross serrations

DERF NEEDLE HOLDER

4 3/4" (121mm)



OM 41-0130
5 1/4" (133mm)
convex jaws

OM 41-0132
7 1/4" (184mm)
convex jaws

BROWN NEEDLE HOLDER

Fine serrations

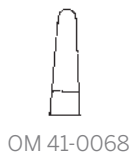
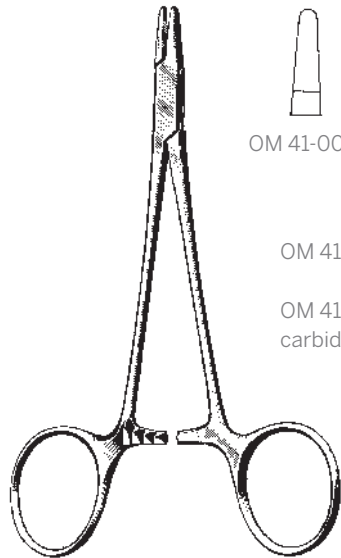

OM 41-0068

OM 41-0070
carbide

WEBSTER NEEDLE HOLDER

5" (127mm) Smooth



OM 41-0104
5" (127mm)
fenestrated
jaws
serrated

COLLIER NEEDLE HOLDER

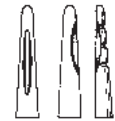
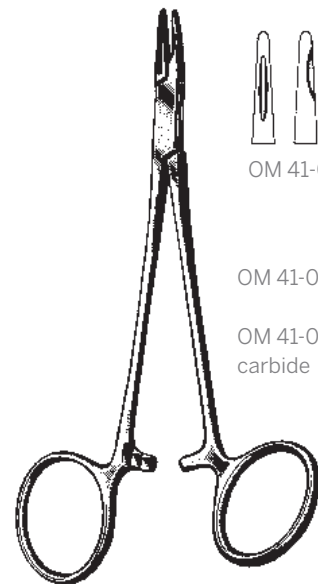

OM 41-0106

OM 41-0108
carbide

NIEVERT NEEDLE HOLDER

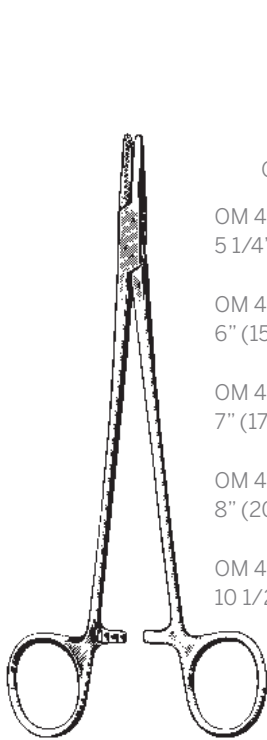

5" (127mm) Smooth, one offset finger ring



- | | |
|---|---|
|  |  |
| OM 41-0270 | OM 41-0302 |
| OM 41-0270
5 1/4" (133mm) | Carbide
OM 41-0300
5" (127mm) |
| OM 41-0272
6" (152mm) | OM 41-0302
6" (152mm) |
| OM 41-0278
7" (178mm) | OM 41-0308
7" (178mm) |
| OM 41-0284
8" (203mm) | OM 41-0314
8" (203mm) |
| OM 41-0286
10 1/2" (267mm) | OM 41-0316
10 1/2" (267mm) |
| | Left hand
OM 41-0302L
6" (152mm) |

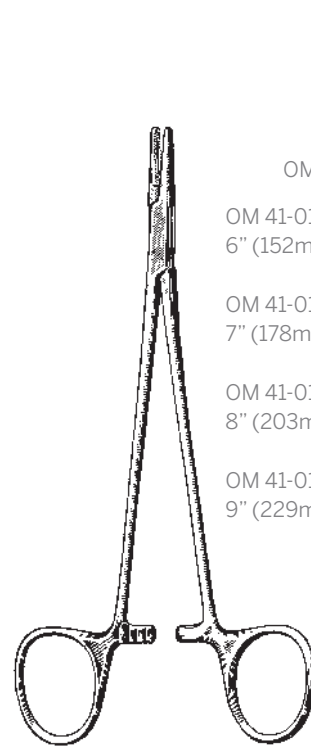

MAYO HEGAR NEEDLE HOLDER
Serrated

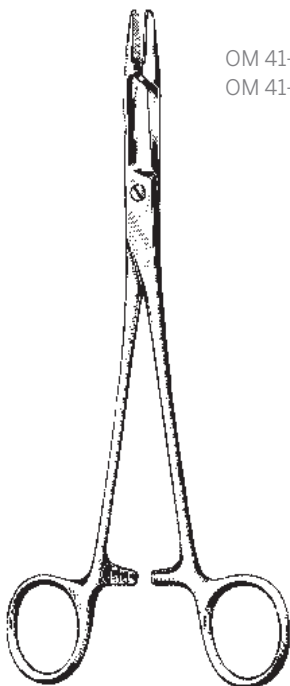

- | | |
|---|---|
|  |  |
| OM 41-0170 | OM 41-0174 |
| OM 41-0170
6" (152mm) | Carbide
OM 41-0174
6" (152mm) |
| OM 41-0171
7" (178mm) | OM 41-0175
7" (178mm) |
| OM 41-0172
8" (203mm) | OM 41-0176
8" (203mm) |
| OM 41-0173
9" (229mm) | OM 41-0178
9" (229mm) |

CRILE-WOOD (DEBAKEY) NEEDLE HOLDER
Serrated



- | | |
|---|---|
|  |  |
| OM 41-0424
OM 41-0440 | OM 41-0428
OM 41-0448 |
| OM 41-0424
4 3/4" (121mm) delicate serrated* | |
| OM 41-0426
4 3/4" (121mm) delicate smooth* | |
| OM 41-0428
5 1/2" (140mm) serrated | |
| OM 41-0432
6 1/2" (165mm) serrated | |
| OM 41-0434
7 1/2" (191mm) serrated | |
| Carbide | |
| OM 41-0440
4 3/4" (121mm) delicate serrated* | |
| OM 41-0446
4 3/4" (121mm) delicate smooth* | |
| OM 41-0448
5 1/2" (140mm) serrated | |
| OM 41-0452
6 1/2" (165mm) serrated | |
| OM 41-0454
7 1/2" (191mm) serrated | |
| * For suture sizes 5-0, 6-0, 7-0 only. | |

OLSEN-HEGAR NEEDLE HOLDER
Combination needle holder and suture scissors

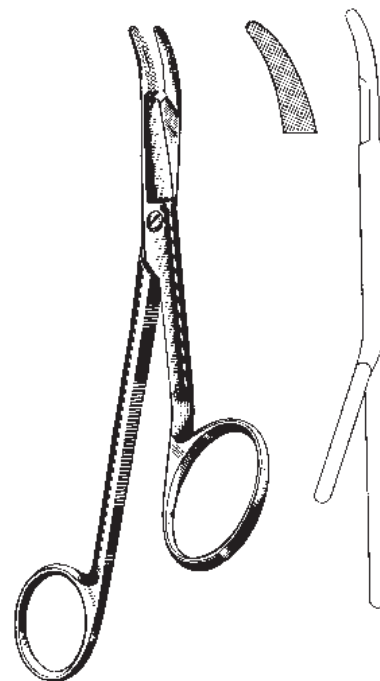

- Curved
OM 41-0333
6 1/2" (165mm)
one fenestrated jaw one angled finger ring

GILLIES NEEDLE HOLDER
Combination needle holder and suture scissors

NEEDLE HOLDER

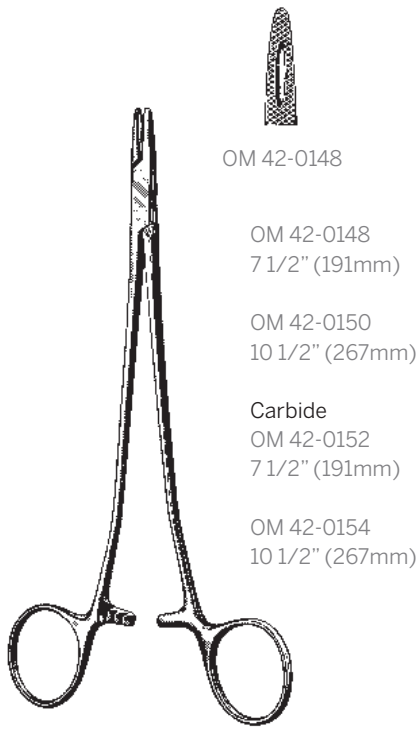

OM 42-0148

OM 42-0148
7 1/2" (191mm)

OM 42-0150
10 1/2" (267mm)

Carbide
OM 42-0152
7 1/2" (191mm)

OM 42-0154
10 1/2" (267mm)

SAROT NEEDLE HOLDER
Serrated

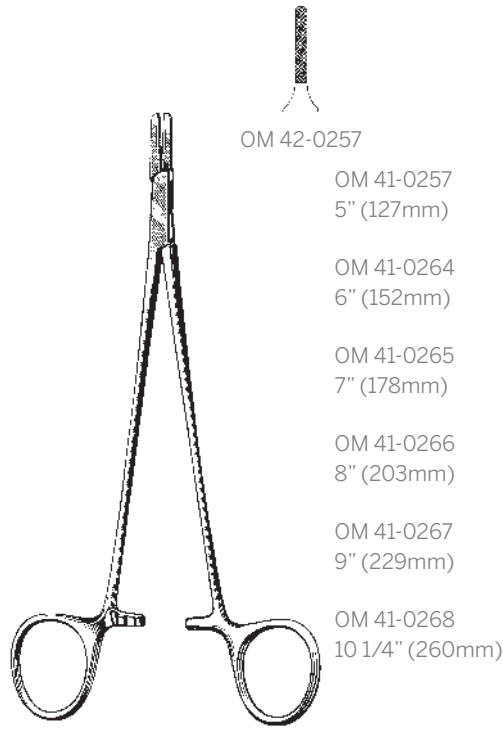

OM 42-0257

OM 41-0257
5" (127mm)

OM 41-0264
6" (152mm)

OM 41-0265
7" (178mm)

OM 41-0266
8" (203mm)

OM 41-0267
9" (229mm)

OM 41-0268
10 1/4" (260mm)

RYDER NEEDLE HOLDER
Serrated carbide



OM 41-0240

OM 41-0240
5" (127mm)

OM 41-0242
6" (152mm)

OM 41-0244
7" (178mm)

OM 41-0246
8" (203mm)

OM 41-0248
9" (229mm)

RYDER MICRO NEEDLE HOLDER
Serrated carbide

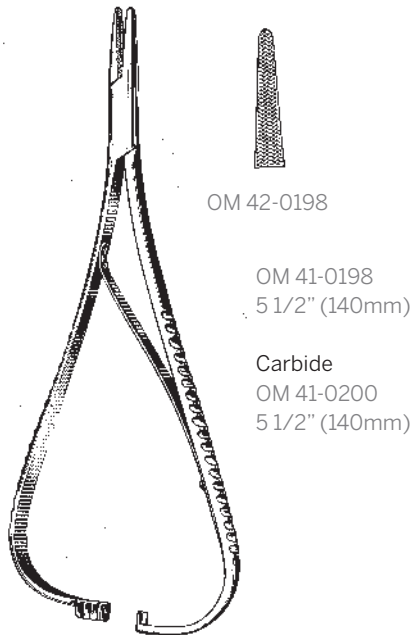

OM 42-0198

OM 41-0198
5 1/2" (140mm)

Carbide
OM 41-0200
5 1/2" (140mm)

MATHIEU NEEDLE HOLDER
Serrated

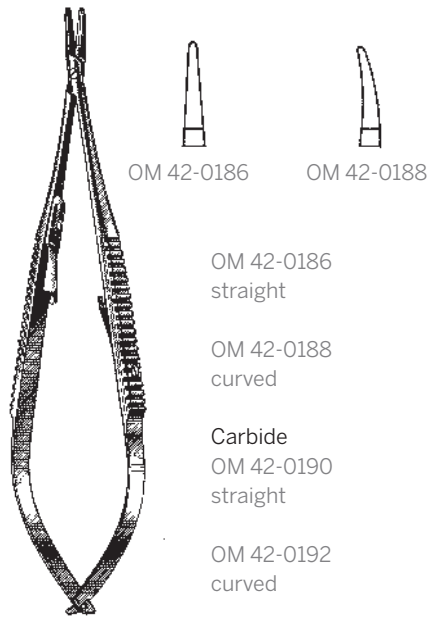

OM 42-0186

OM 42-0186
straight

OM 42-0188
curved

Carbide
OM 42-0190
straight

OM 42-0192
curved

CASTROVIEJO MICRO NEEDLE HOLDER
5 1/2" (140mm) smooth, with lock

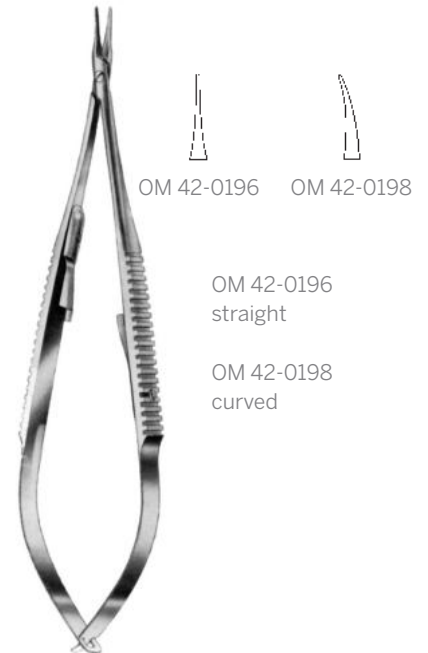

OM 42-0196

OM 42-0196
straight

OM 42-0198
curved

CASTROVIEJO MICRO NEEDLE HOLDER
5 1/2" (140mm) extra delicate, smooth, with lock

OAL = Overall Length
 WL = Working Length
 FR = French Gauge (1 french = .33mm)

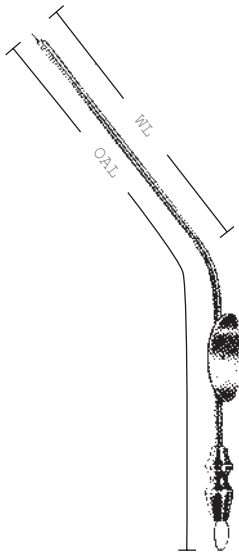

	OAL	FR	WL
OM 42-0832	5 1/2" (140mm)	3	75mm
OM 42-0834	5 1/2" (140mm)	5	75mm
OM 42-0836	5 1/2" (140mm)	7	75mm

BARON SUCTION TUBE

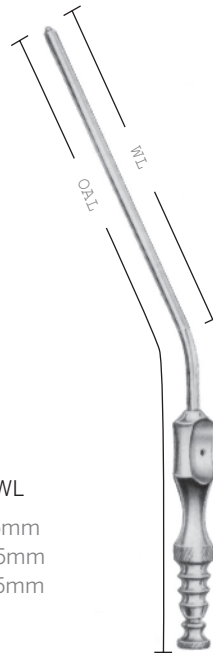

	OAL	FR	WL
OM 42-0823	7" (178mm)	6	90mm
OM 42-0824	7" (178mm)	7	90mm
OM 42-0825	7" (178mm)	8	90mm
OM 42-0826	7" (178mm)	10	90mm
OM 42-0827	7" (178mm)	11	90mm
OM 42-0830	7" (178mm)	12	90mm
OM 42-0823L	9" (229mm)	6	130mm
OM 42-0824L	9" (229mm)	7	130mm
OM 42-0825L	9" (229mm)	8	130mm
OM 42-0826L	9" (229mm)	10	130mm
OM 42-0827L	9" (229mm)	11	130mm
OM 42-0830L	9" (229mm)	12	130mm

FRAZIER SUCTION TUBE

Angled 30°

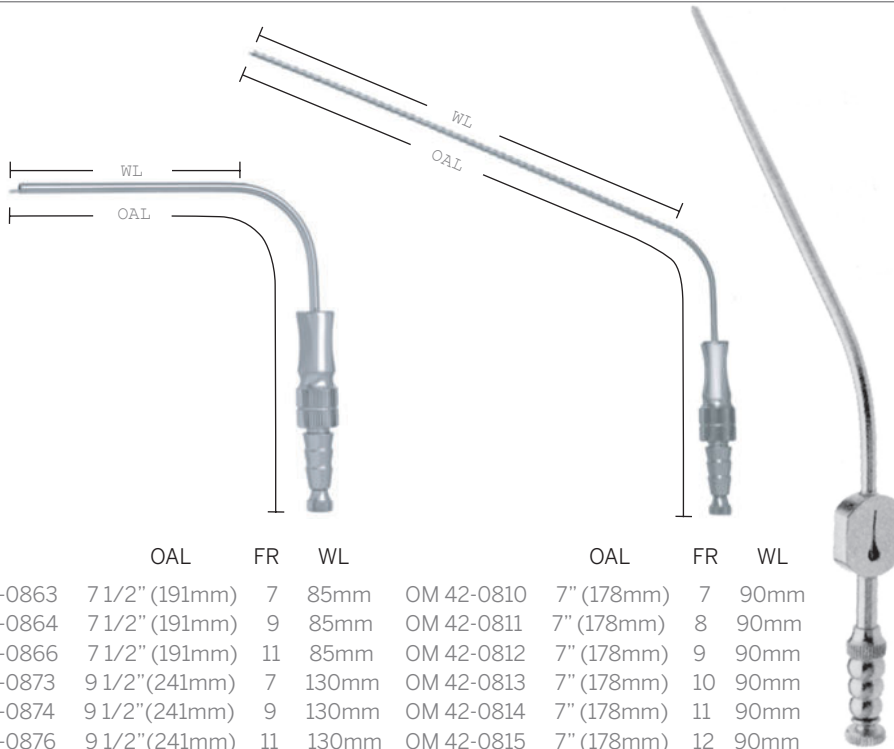

Tear drop opening allows surgeon to regulate force of suction.

	OAL	FR	WL
OM 42-0863	7 1/2" (191mm)	7	85mm
OM 42-0864	7 1/2" (191mm)	9	85mm
OM 42-0866	7 1/2" (191mm)	11	85mm
OM 42-0873	9 1/2" (241mm)	7	130mm
OM 42-0874	9 1/2" (241mm)	9	130mm
OM 42-0876	9 1/2" (241mm)	11	130mm

FRAZIER SUCTION TUBE

Angled 90°

	OAL	FR	WL
OM 42-0810	7" (178mm)	7	90mm
OM 42-0811	7" (178mm)	8	90mm
OM 42-0812	7" (178mm)	9	90mm
OM 42-0813	7" (178mm)	10	90mm
OM 42-0814	7" (178mm)	11	90mm
OM 42-0815	7" (178mm)	12	90mm

FRAZIER SUCTION TUBE

Angled 75°

OM 42-0880	6 1/4" (159mm)	4 french
OM 42-0881	6 1/4" (159mm)	5 french
OM 42-0882	6 1/4" (159mm)	6 french
OM 42-0883	6 1/4" (159mm)	7 french
OM 42-0884	6 1/4" (159mm)	8 french
OM 42-0885	6 1/4" (159mm)	9 french
OM 42-0890	7" (178mm)	4 french
OM 42-0891	7" (178mm)	5 french
OM 42-0892	7" (178mm)	6 french
OM 42-0893	7" (178mm)	7 french
OM 42-0894	7" (178mm)	8 french
OM 42-0895	7" (178mm)	9 french
OM 42-0901	8" (203mm)	4 french
OM 42-0902	8" (203mm)	5 french
OM 42-0903	8" (203mm)	6 french
OM 42-0904	8" (203mm)	7 french
OM 42-0905	8" (203mm)	8 french
OM 42-0906	8" (203mm)	9 french

FUKUSHIMA SUCTION TUBE

SUCTION TUBES/SCALPEL HANDLES

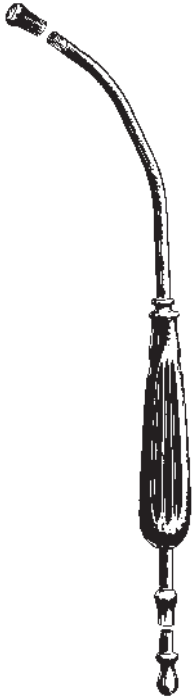

OM 58-0228
11 1/2" (292mm)
chrome

OM 58-0230
front tip only

YANKAUER SUCTION TUBE



1 french = .33mm

OM 42-0844
23 french curved

OM 42-0852
30 french straight

POOLE SUCTION TUBE
9" (229mm) Chrome



OM 29-0070
for blades 61 through 67

**MINI SCALPEL HANDLE
#3K**



OM 29-0073

**SCALPEL HANDLE MINI
(BEAVER) #3K 6"**



OM 29-0071

**SCALPEL HANDLE MINI
(BEAVER) #3K 5"**



OM 29-0058
for blades
10 through 15

SCALPEL HANDLE #3



OM 29-0059
mm and cm graduations
for blades 10 through 15

SCALPEL HANDLE #3



OM 29-0060
for blades
20 through 25

SCALPEL HANDLE #4



OM 29-0061
extra long
8 1/2" (216mm)
for blades 10 through 15

SCALPEL HANDLE #3L



OM 29-0062
for blades 10 through 15

SCALPEL HANDLE #7



OM 29-0064
extra fine
for blades 10 through 15

SCALPEL HANDLE #9



- OM 42-0608 4 1/2" (114mm)
- OM 42-0610 5" (127mm)
- OM 42-0612 5 1/2" (140mm)
- OM 42-0614 6" (152mm)
- OM 42-0616 8" (203mm)
- OM 42-0618 10" (254mm)
- OM 42-0620 12" (305mm)

PROBE WITH EYE
Malleable stainless

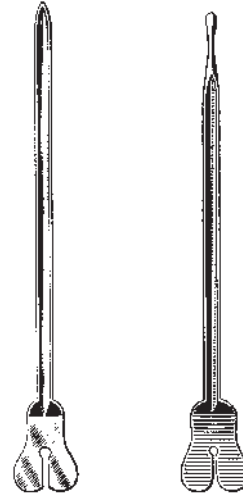

- With tongue tie**
- OM 42-0646 4 1/2" (114mm)
- OM 42-0647 5" (127mm)
- OM 42-0648 5 1/2" (140mm)
- OM 42-0649 6" (152mm)
- With probe and tongue tie**
- OM 42-0654 5" (127mm)
- OM 42-0655 5 1/2" (140mm)
- OM 42-0656 6" (152mm)

GROOVED DIRECTORS



- OM 28-0460
7" (178mm) small
- OM 28-0468
8" (203mm) large

**TAYLOR
PERCUSSION HAMMER**

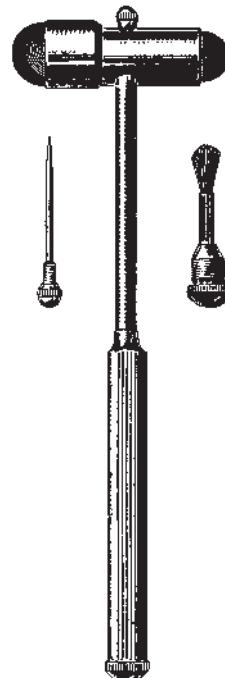

- OM 28-0492
7 3/4" (197mm)
chrome with brush and needle

**BUCK
NEUROLOGICAL HAMMER**

UTILITY CLIP MINI

OM CK-10

UTILITY CLIP MINI LARGE

OM CK-40



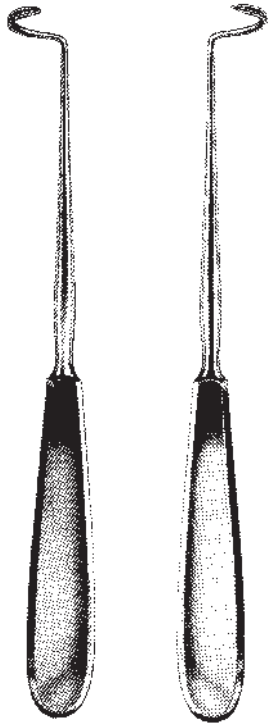

OM 42-0558 blunt left
OM 42-0560 blunt right
OM 42-0562 sharp left
OM 42-0564 sharp right

DESCHAMPS LIGATURE CARRIER
8"(203mm)



OM 53-0450
0.12mm
1x2 teeth

OM 53-0456
0.5mm
1x2 teeth

CASTROVIEJO MICRO TYING FORCEPS
4"(102mm) Straight with tying platform

*Bipolar forceps
Available in most styles and tip sizes.*



OM 68-0026
4"(102mm)
8mm platform
0.5mm tip

JEWELERS FORCEP