

CAST ROOM INSTRUMENTS



SECTION E



To cut or break bandages, stockinette, drapes, felt, plaster or aluminum casts.

CONTENTS

Scissors and Shears	1-3
Saws	3
Knives	3
Cast Breakers	3-4
Cast Spreaders	4-5

ORTHO+MED
The Surgical Instrument Specialists

SUPER-CUT BANDAGE SCISSORS

OrthoMed developed these remarkably sharp scissors in response to the demands of doctors, nurses, and other O.R. personnel.

Hospital tests show that these scissors cut multiple layers of stockinette, bandages, drapes, and moleskin with ease.

- Very little hand strength is required for cutting, putting less strain on thumb and forearm.
- Perfect cutting control because you don't have to force them to cut.
- Scissors cut faster, saving critical time in the O.R.
- Retain their sharpness longer than ordinary scissors.
- Not recommended for cutting plaster.

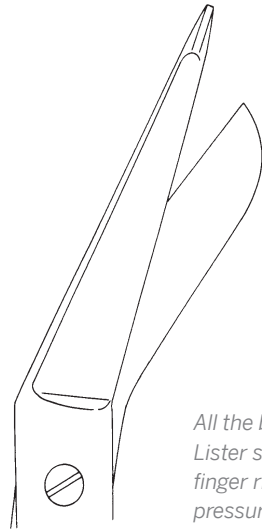
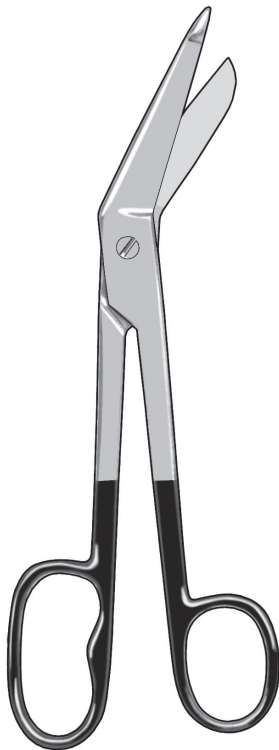

All the benefits of our Super-Cut Lister scissors plus an oversized finger ring, which helps relieve pressure on the third metacarpal.

OM 35-0214
8" (203mm)

SUPER-CUT LISTER BANDAGE SCISSORS WITH LARGE FINGER RING

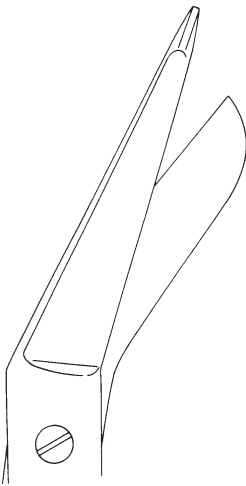

OM 35-0210

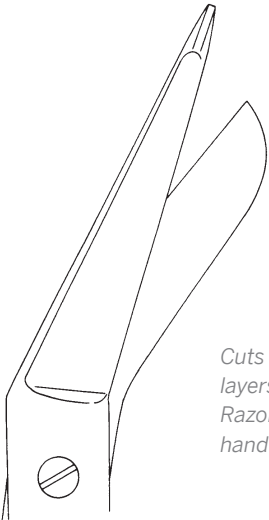

OM 35-0212

Cuts bandages and multiple layers of dressings with ease. Razor-sharp blades reduce hand fatigue.

OM 35-0210
5 1/2" (140mm)
stainless

OM 35-0212
7 1/4" (184mm)
stainless

SUPER-CUT LISTER BANDAGE SCISSORS



For light plaster and cloth.

OM 31-0832 6" (152mm)
Lister-type (not pictured)

OM 31-0830 7 1/2" (191mm)
one serrated blade
with autoclavable plastic finger rings

UTILITY SHEARS

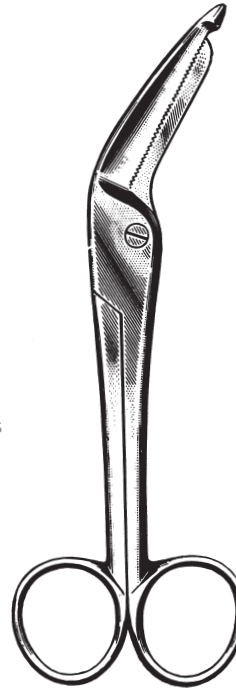

For light weight plaster or aluminum casts.

OM 31-0834
7 1/2" (191mm)
one serrated blade

HERCULES SCISSORS



Effective for cloth or cotton wadding.

OM 31-0836
8" (203mm)
one serrated blade
with wire cutting notch

**ORTHOMED
UTILITY SHEARS**

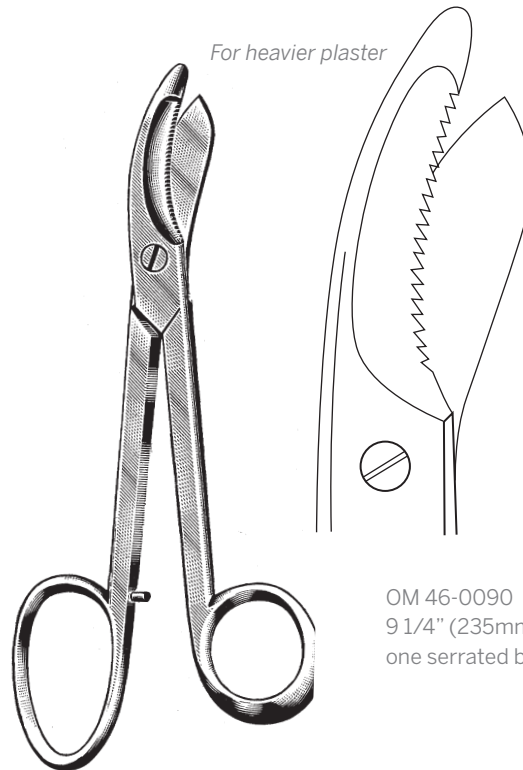

For heavier plaster

OM 46-0090
9 1/4" (235mm)
one serrated blade

BRUNS SHEARS

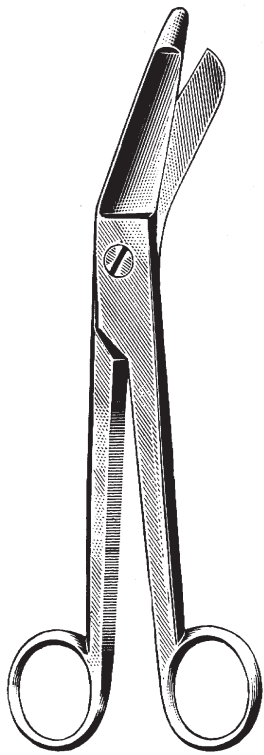

*Useful for cutting
tape and bandages.*

OM 46-0060
8" (203mm)

ESMARCH SHEARS

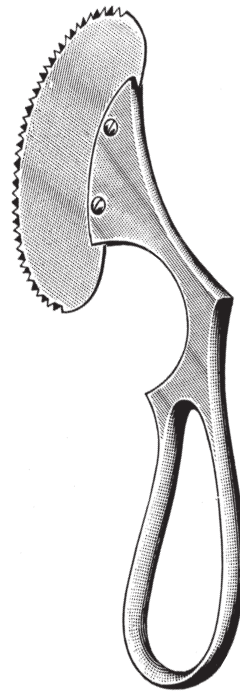

OM 46-0056
6" (152mm)
with stainless blade
chrome handle

ENGEL PLASTER SAW



OM 46-0058
7" (178mm)
with stainless handle

REINER PLASTER KNIFE

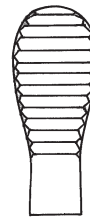

*For lightweight
cast breaking
and trimming.*

OM 46-0188
7" (178mm)
deep serrated tips



PEDIATRIC CAST BREAKER

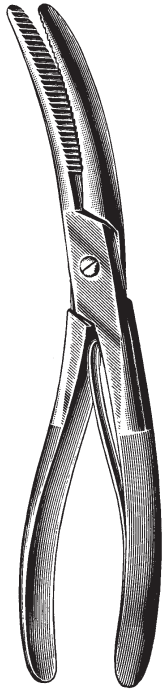

OM 46-0186
7" (178mm)
small

OM 46-0184
9 1/2" (241mm)



OM 46-0186



OM 46-0184

For cast removal.

PLASTER BREAKER WOLFF (BOEHLER)
deep serrated tips

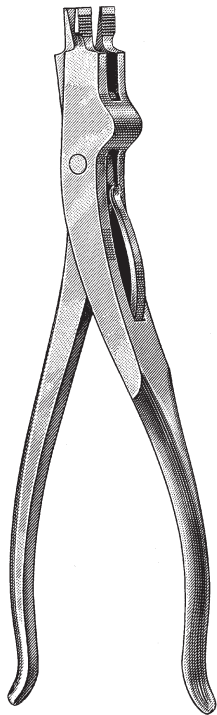

OM 46-0134
9" (229mm) serrated
3 prongs

OM 46-0133
9" (229mm) serrated
3 prongs

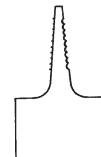
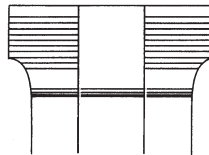

*To relieve cast pressure
or for cast removal. One
handed operation.*

**ORTHOMED
CAST SPREADER**

WALTON CAST SPREADER

*To relieve cast pressure
or for cast removal.*

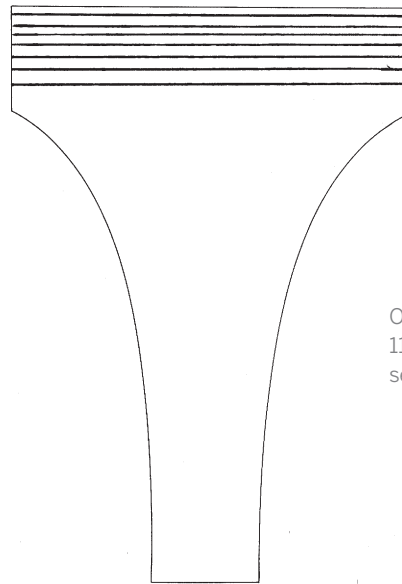
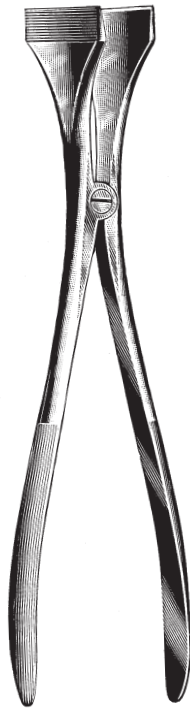

OM 46-0138
11" (279mm)
serrated

**HENNIG PLASTER
SPREADER**

For cast removal.

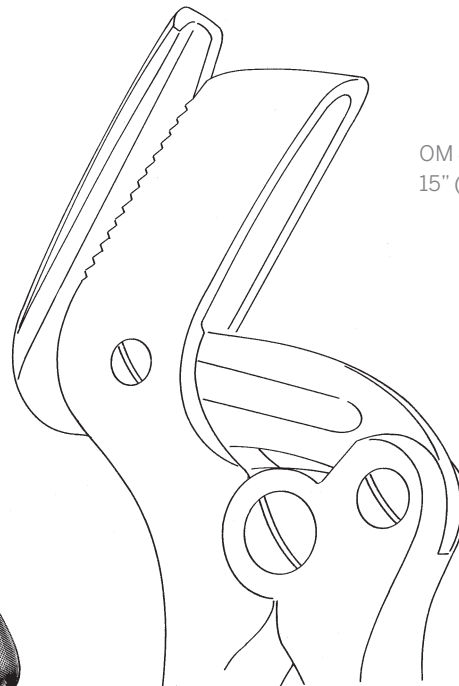

OM 46-0156
15" (381mm)

STILLE PLASTER SHEARS