

ARTHROSCOPIC INSTRUMENTS



SECTION Q

CONTENTS

Arthroscopic Instruments	1
Biopsy Scissors and Punches	2-8
Grasping Forceps	9
Rinsing Cannula	10
Micro Fracture Picks	10



To grasp, hold, rotate, excise, trim, and cut ligaments and tendons during arthroscopic procedures.

ORTHO+MED
The Surgical Instrument Specialists



ROUND KNURLED HANDLE

TRI HANDLE

	ROUND KNURLED HANDLE	TRI HANDLE	
MENISCUS PROBE	OM 80-0005 2.5mm	OM 80-0003 3.0mm	
MENISCUS PROBE	OM 80-0010 3.5mm	OM 80-0012 5.0mm	
BAYONET KNIFE	OM 80-0015	OM 80-0017	
SCALPEL KNIFE	OM 80-0020	OM 80-0022	
SMILLIE MENISCOTOME	OM 80-0025 3.0mm	OM 80-0027	
SMILLIE MENISCOTOME	OM 80-0030 5.0mm	OM 80-0032	
SMILLIE MENISCOTOME	OM 80-0035 7.0mm	OM 80-0036	
RING CURETTE	OM 80-0040 3.0mm	OM 80-0042	
RING CURETTE	OM 80-0045 7.0mm	OM 80-0047	
SPOON	OM 80-0050 3.0mm	OM 80-0053	
BANANA KNIFE	OM 80-0055 smooth	OM 80-0057	
BANANA KNIFE	OM 80-0060 serrated	OM 80-0062	
HOOK KNIFE	OM 80-0065	OM 80-0067	
PLANING KNIFE	OM 80-0070	OM 80-0072	
SICKLE KNIFE	OM 80-0075	OM 80-0077	
ROSETTE KNIFE	OM 80-0080 5.0mm	OM 80-0083	
CARTILAGE FILE	OM 80-0085 fine	OM 80-0087	
SMILLIE MENISCOTOME	OM 80-0090 3.0mm 60° right		
SMILLIE MENISCOTOME	OM 80-0095 3.0mm 60° left		



HANDLE STYLE A



HANDLE STYLE B

Please indicate handle style by adding corresponding letter after part number when placing an order.

Shaft Length 5 1/8" (130mm)	Shaft Diameter	 Hook Scissors	 Hook Punch with Scoop 1.6mm	 Hook Punch Set Down 1.6mm	 Hook Punch Cut Angular 1.6mm
 Straight	2.7mm	OM 80-0100	OM 80-0190	OM 80-0280	OM 80-0370
	3.5mm	OM 80-0105	OM 80-0195	OM 80-0285	
 30° Right	2.7mm	OM 80-0110	OM 80-0200	OM 80-0290	OM 80-0375
	3.5mm	OM 80-0115	OM 80-0205	OM 80-0295	
 30° Left	2.7mm	OM 80-0120	OM 80-0210	OM 80-0300	OM 80-0380
	3.5mm	OM 80-0125	OM 80-0215	OM 80-0305	
 45° Right	2.7mm	OM 80-0130	OM 80-0220	OM 80-0310	OM 80-0385
	3.5mm	OM 80-0135	OM 80-0225	OM 80-0315	
 45° Left	2.7mm	OM 80-0140	OM 80-0230	OM 80-0320	OM 80-0390
	3.5mm	OM 80-0145	OM 80-0235	OM 80-0325	
 7° Upward	2.7mm	OM 80-0150	OM 80-0240	OM 80-0330	OM 80-0395
	3.5mm	OM 80-0155	OM 80-0245	OM 80-0335	
 7° Downward	2.7mm	OM 80-0160	OM 80-0250	OM 80-0340	OM 80-0400
	3.5mm	OM 80-0165	OM 80-0255	OM 80-0345	
 15° Upward	2.7mm	OM 80-0170	OM 80-0260	OM 80-0350	OM 80-0405
	3.5mm	OM 80-0175	OM 80-0265	OM 80-0355	
 15° Downward	2.7mm	OM 80-0180	OM 80-0270	OM 80-0360	OM 80-0410
	3.5mm	OM 80-0185	OM 80-0275	OM 80-0365	















HANDLE STYLE A



HANDLE STYLE B

Please indicate handle style by adding corresponding letter after part number when placing an order.

Shaft Length 5 1/8" (130mm)	Shaft Diameter	 Hook Punch 15° Upwards 1.6mm	 Wide Jaw Punch Large 4.5mm	 Wide Jaw Punch Medium 3.5mm	 Wide Jaw Punch Small 2.5mm
 Straight	3.5mm	OM 80-0415	OM 80-0460	OM 80-0505	OM 80-0550
 30° Right	3.5mm	OM 80-0420	OM 80-0465	OM 80-0510	OM 80-0555
 30° Left	3.5mm	OM 80-0425	OM 80-0470	OM 80-0515	OM 80-0560
 45° Right	3.5mm	OM 80-0430	OM 80-0475	OM 80-0520	OM 80-0565
 45° Left	3.5mm	OM 80-0435	OM 80-0480	OM 80-0525	OM 80-0570
 7° Upward	3.5mm	OM 80-0440	OM 80-0485	OM 80-0530	OM 80-0575
 7° Downward	3.5mm	OM 80-0445	OM 80-0490	OM 80-0535	OM 80-0580
 15° Upward	3.5mm	OM 80-0450	OM 80-0495	OM 80-0540	OM 80-0585
 15° Downward	3.5mm	OM 80-0455	OM 80-0500	OM 80-0545	OM 80-0590









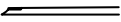

HANDLE STYLE A



HANDLE STYLE B

Please indicate handle style by adding corresponding letter after part number when placing an order.

Shaft Length 5 1/8" (130mm)	Shaft Diameter	Wide Jaw Punch 15° Upwards 4.5mm	Wide Jaw Punch 15° Upwards 3.5mm	Wide Jaw Punch 15° Upwards 2.5mm	Wide Jaw Punch 45° Upwards 2.0mm
 Straight	3.5mm	OM 80-0595	OM 80-0640	OM 80-0685	OM 80-0730
 30° Right	3.5mm	OM 80-0600	OM 80-0645	OM 80-0690	
 30° Left	3.5mm	OM 80-0605	OM 80-0650	OM 80-0695	
 45° Right	3.5mm	OM 80-0610	OM 80-0655	OM 80-0700	
 45° Left	3.5mm	OM 80-0615	OM 80-0660	OM 80-0705	
 7° Upward	3.5mm	OM 80-0620	OM 80-0665	OM 80-0710	
 7° Downward	3.5mm	OM 80-0625	OM 80-0670	OM 80-0715	
 15° Upward	3.5mm	OM 80-0630	OM 80-0675	OM 80-0720	
 15° Downward	3.5mm	OM 80-0635	OM 80-0680	OM 80-0725	







HANDLE STYLE A



HANDLE STYLE B

Please indicate handle style by adding corresponding letter after part number when placing an order.

Shaft Length 5 1/8" (130mm)	Shaft Diameter	 Punch 45° with Scoop 1.6mm	 Punch 45° Blunt 1.6mm	 Punch 90° with Scoop 1.6mm	 Punch 90° Blunt 1.6mm
Right angled	2.7mm	OM 80-0775	OM 80-0785	OM 80-0795	OM 80-0805
Left angled	2.7mm	OM 80-0780	OM 80-0790	OM 80-0800	OM 80-0810

Shaft Length 5 1/8" (130mm)	Shaft Diameter	 Hook Scissors 45°	 Punch 45° with Scoop 1.6mm	 Punch 45° Blunt 1.6mm	 Punch 90° with Scoop 1.6mm	 Punch 90° Blunt 1.6mm
Right angled	3.5mm	OM 80-0815	OM 80-0825	OM 80-0835	OM 80-0845	OM 80-0855
Left angled	3.5mm	OM 80-0820	OM 80-0830	OM 80-0840	OM 80-0850	OM 80-0860



HANDLE STYLE A



HANDLE STYLE B

Please indicate handle style by adding corresponding letter after part number when placing an order.

Shaft Length 5 1/8" (130mm)	Shaft Diameter	Wide Jaw Punch 90° Medium 3.0mm	Wide Jaw Punch 90° Small 2.0mm
Right angled	3.5mm	OM 80-0865	OM 80-0875
Left angled	3.5mm	OM 80-0870	OM 80-0880

Basket punches are available in this handle style in straight, upbite, curved right and left, upswept and many tips and tip sizes. If you would like to check if we offer this handle in the size you need please contact us.



BASKET PUNCH DUCKBILL

OM ATH 0120133
8 3/4" (220mm)
2.7mm straight









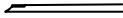

HANDLE STYLE A

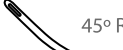

HANDLE STYLE B

Please indicate handle style by adding corresponding letter after part number when placing an order.

Shaft Length 5 1/8" (130mm)	Shaft Diameter	Scissors Punch 0.8mm	Scissors Punch 15° Upwards 0.8mm	Punch Retrograde Cut Left 2.5mm	Punch Retrograde Cut Right 2.5mm
 Straight	3.5mm	OM 80-0885	OM 80-0912	OM 80-0930	OM 80-0932
 30° Right	3.5mm	OM 80-0890	OM 80-0914		
 30° Left	3.5mm	OM 80-0895	OM 80-0916		
 45° Right	3.5mm	OM 80-0900	OM 80-0918		
 45° Left	3.5mm	OM 80-0902	OM 80-0920		
 7° Upward	3.5mm	OM 80-0904	OM 80-0922		
 7° Downward	3.5mm	OM 80-0906	OM 80-0924		
 15° Upward	3.5mm	OM 80-0908	OM 80-0926		
 15° Downward	3.5mm	OM 80-0910	OM 80-0928		



HANDLE STYLE A



HANDLE STYLE B



HANDLE STYLE C

Please indicate handle style by adding corresponding letter after part number when placing an order.

Shaft Length	Shaft Diameter				
		Grasping Forceps	Grasping Forceps 1 x 2 Teeth	Grasping Forceps 1 x 2 Teeth	Grasping and Biopsy Forceps
without Ratchet	2.7mm	OM 80-0934	OM 80-0938	OM 80-0942	OM 80-0946
with Ratchet	2.7mm	OM 80-0936	OM 80-0940	OM 80-0944	OM 80-0948

Shaft Length	Shaft Diameter					
		Grasping Forceps	Grasping Forceps 1 x 2 Teeth	Grasping Forceps 1 x 2 Teeth	Grasping and Biopsy Forceps	Biopsy Spoon Forceps
without Ratchet	3.5mm	OM 80-0950	OM 80-0954	OM 80-0958	OM 80-0962	OM 80-0966
with Ratchet	3.5mm	OM 80-0952	OM 80-0956	OM 80-0960	OM 80-0964	OM 80-0968

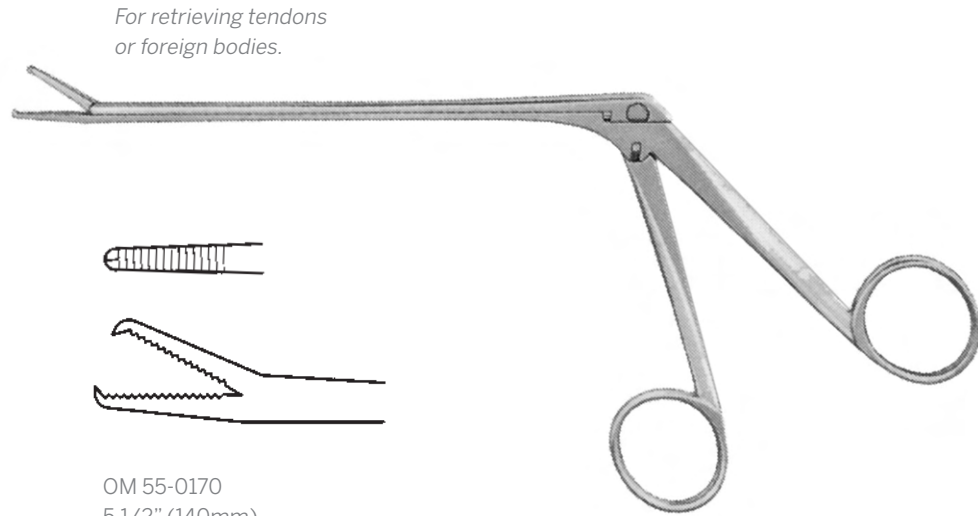

OM 55-0170
5 1/2" (140mm)
shaft
serrated jaw with 1x2 tip

HOEN GRASPING FORCEPS



OM 55-0172
5 1/2" (140mm)
serrated jaw with blood groove

OM 55-0173
4 3/4" (120mm)
serrated jaw with blood groove

LOOSE BODY GRASPER

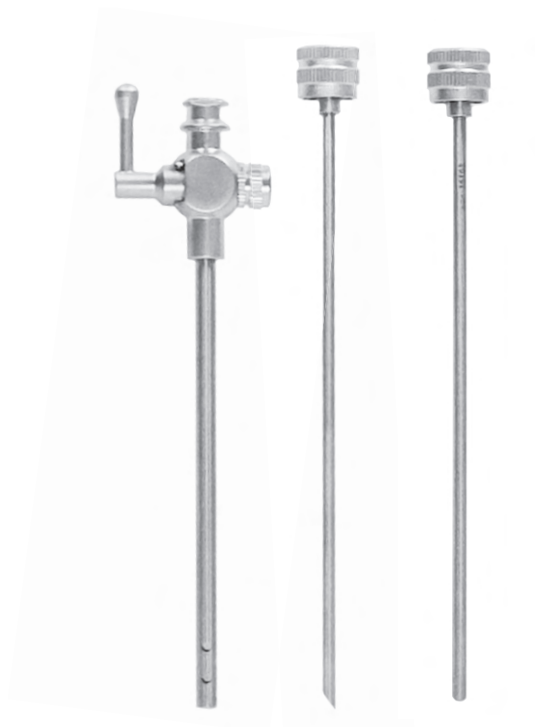

RINSING CANNULA with STOPCOCK

OM TO 579-260-00 Complete Set 3.2mm
Includes Cannula with Stopcock with Sharp and Blunt Trocar

OM TO 579-270-00 Complete Set 4.5mm
Includes Cannula with Stopcock with Sharp and Blunt Trocar

OM TO 579-260-01 Cannula Only 3.2mm
OM TO 579-260-02 Trocar Pyramidal
OM TO 579-260-03 Trocar Blunt

OM TO 579-270-01 Cannula Only 4.5mm
OM TO 579-270-02 Trocar Pyramidal
OM TO 579-270-03 Trocar Blunt



Picks feature an ergonomic carbon fiber handle with integrated impact protection for use with mallet. 5 different tip angles give surgeon full flexibility in micro fracture approaches.

MICRO FRACTURE CHONDRO PICKS

OM 89-0310 Straight tip
OM 89-0313 25 degree tip
OM 89-0316 40 degree tip
OM 89-0318 60 degree tip
OM 89-0319 90 degree tip