

BONE SCREW MANAGEMENT

SECTION U

CONTENTS

Drill Bits	1
Sterilization Case	2
Countersinks	3
Taps	4
Depth Gauges/Couping Handles	5
Drill Guides and Sleeves	6-9
Screwdrivers	10-14
Tension Devices	15-16
Wrenches	16-17
Bending Instruments	18-25
Screw Removal Set	26-27

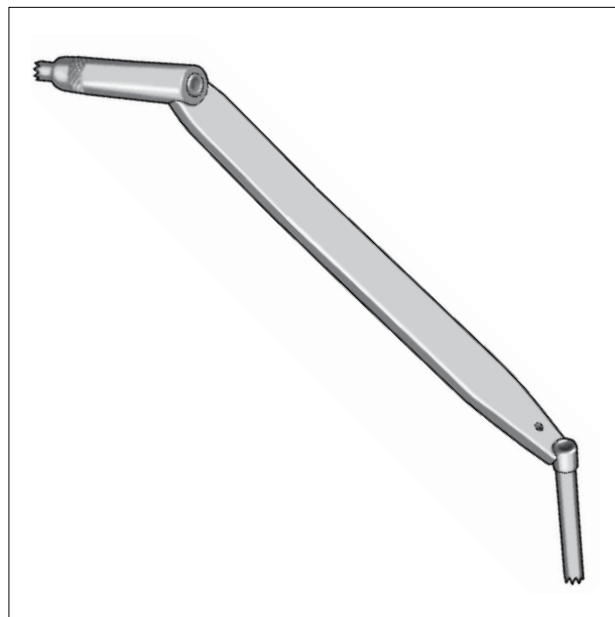

To implant bone screws and plates during internal fracture fixation.

Note: For the correct instrumentation, please refer to the chart on pages T1-T2 or Section BB. Please inquire about any style or size drill bit not shown here.

DRILL BITS

With quick coupling ends



	diameter	Overall length	Working length	Flute length
OM 48-0051	1.1mm	60mm	35mm	20mm
OM 48-0052	1.5mm	85mm	60mm	23mm
OM SYN310510	1.8mm	100mm	75mm	45mm
OM 48-0054	2.0mm	100mm	75mm	50mm
OM 48-0057	2.5mm	110mm	85mm	50mm
OM SYN310.23	2.5mm	180mm	153mm	45mm
OM 48-0058	2.7mm	100mm	75mm	50mm
OM 48-0061	3.2mm	145mm	120mm	50mm
OM 48-0060	3.2mm	195mm	170mm extra long	50mm
OM 48-0063	3.5mm	110mm	85mm	50mm
OM 48-0050	3.5mm	195mm	170mm extra long	50mm
OM 48-0066	5.5mm	195mm	170mm extra long	55mm
OM 48-0067	4.5mm	145mm	120mm	50mm
OM 48-0068	4.5mm	195mm	170mm extra long	50mm
OM 48-0069	6.0mm	195mm	170mm extra long	60mm

To drill gliding and threaded holes.

Designed to fit quick coupling handles.
OM 47-0902
OM 47-0904
OM 47-0960

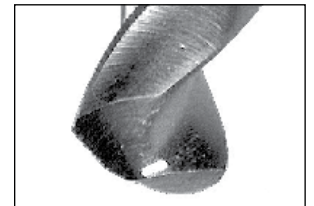

Enlarged to show detail.

DRILL BITS

With round drill chuck end



	diameter	Overall length	Working length
OM 48-0070	1.0mm	55mm	25mm
OM 48-0071	1.5mm	70mm	30mm
OM 48-0073	2.0mm	85mm	38mm
OM 48-0076	2.5mm	95mm	43mm
OM 48-0077	2.7mm	85mm	32mm
OM 48-0080	3.2mm	106mm	48mm
OM 48-0079	3.2mm	180mm	70mm
OM 48-0081	3.5mm	112mm	52mm
OM 48-0082	3.5mm	180mm	70mm extra long
OM 48-0085	4.5mm	180mm	70mm extra long
OM 48-0086	6.0mm	180mm	70mm extra long

Designed to fit any Jacobs chuck drill.

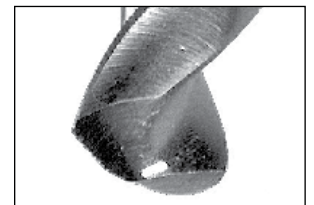

Enlarged to show detail.

THREE-FLUTED DRILL BITS

With quick coupling ends



	diameter	Overall length	Working length	Flute length
OM 47-0986	2.5mm	230mm	205mm	30mm calibrated
OM 47-0979	3.2mm	230mm	205mm	30mm calibrated
OM 47-0981	4.5mm	195mm	170mm	55mm not calibrated

Note: Custom lengths and diameters can be manufactured upon special order. Cannulated drill bits from 5mm to 12mm in diameter are also available by special order.



Enlarged to show detail.

Note: The OrthoMed Drill Bit Sterilization Case holds 5" drill bits for sterilization and storage.

- Drill bit sizes and OrthoMed part numbers are clearly noted on the inside of case for quick identification and reordering.
- Lid opens and raises the internal tray containing drill bits up for easy access.
- Lid folds back and acts as a support to hold the case in an upright position – taking up less room in the O.R.
- When closing lid, the internal tray is lowered and contents are held in place, preventing shifting.
- Top of case locks when closed helping to prevent accidental opening.
- Case has a one piece design – eliminates the possibility of losing or switching case parts.
- Anodized aluminum case is light-weight and built to withstand abuse.
- Fully autoclavable to 270°F.

Designed to provide easy access and identification.

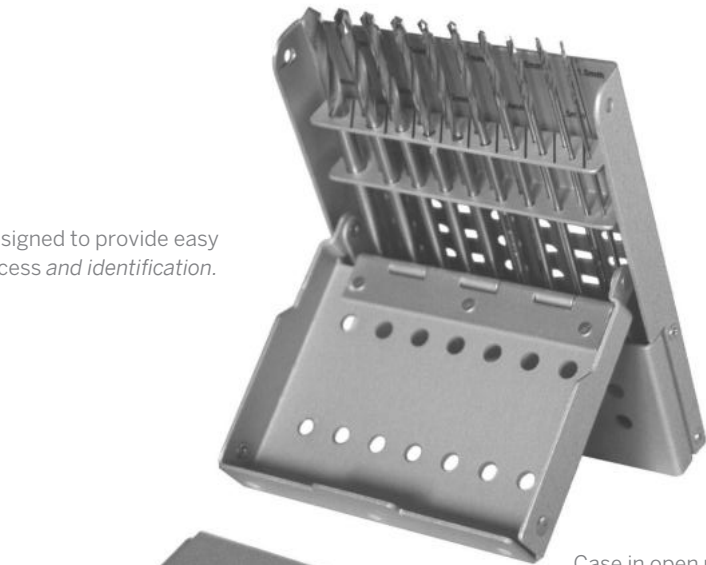

Case in open upright position.



Case in closed position.



5" DRILL BIT STERILIZATION CASE

Holds 5" drill bits for sterilization and storage.

OM 48-0100

5 1/2" X 4 1/4" X 3/4"

5" (127mm) Jacob chuck drill bits are available from OrthoMed and sold separately.

OM 48-0129	1.0mm (2 ea.)	OM 48-0137	3.2mm (2 ea.)
OM 48-0130	1.5mm (2 ea.)	OM 48-0138	3.5mm (2 ea.)
OM 48-0132	2.0mm (2 ea.)	OM 48-0140	4.0mm (2 ea.)
OM 48-0134	2.4mm (2 ea.)	OM 48-0142	4.7mm (2 ea.)
OM 48-0136	2.7mm (2 ea.)	OM 48-0143	6.0mm (1 ea.)
OM 48-0135	2.5mm		

CANNULATED DRILL BITS

with quick coupling ends

OM SYN310.67	2.7mm	OM SYN310.66	4.5mm
OM SYN310.65	3.2mm	OM SYN310.68	3.5mm

Note: Countersinks: used to prepare correct seating for screw head. For correct instrumentation, please refer to the chart on pages T1-T2 or Section BB.

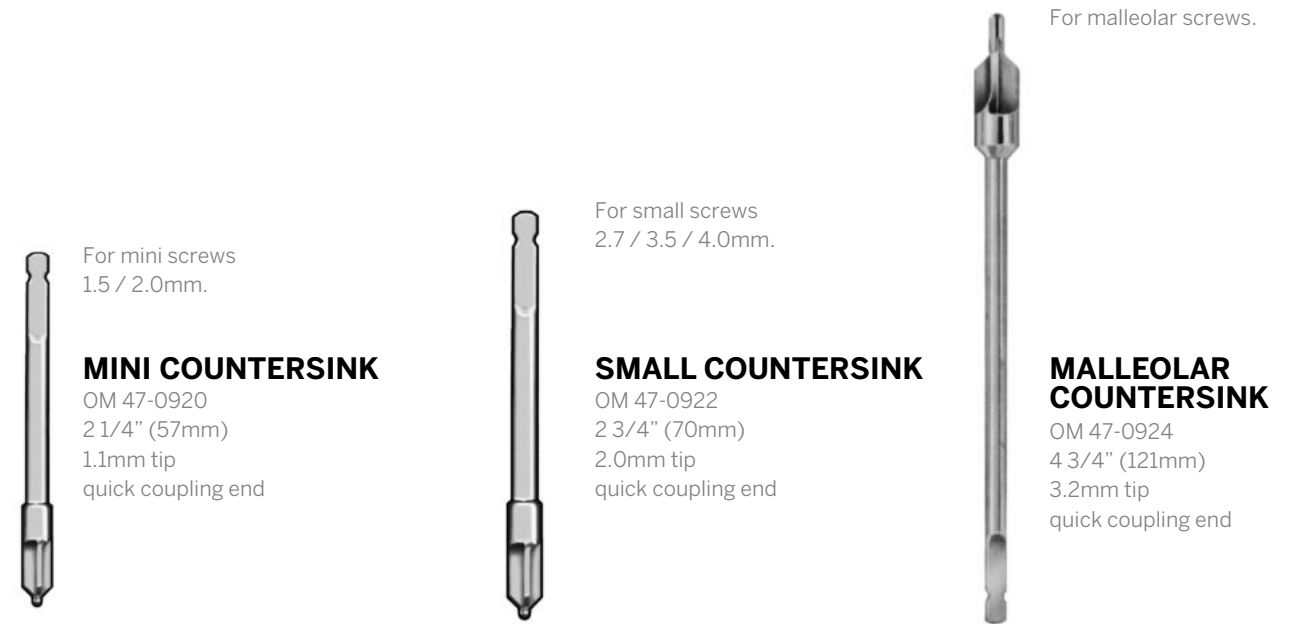

For mini screws
1.5 / 2.0mm.

MINI COUNTERSINK

OM 47-0920
2 1/4" (57mm)
1.1mm tip
quick coupling end

For small screws
2.7 / 3.5 / 4.0mm.

SMALL COUNTERSINK

OM 47-0922
2 3/4" (70mm)
2.0mm tip
quick coupling end

For malleolar screws.

MALLEOLAR COUNTERSINK

OM 47-0924
4 3/4" (121mm)
3.2mm tip
quick coupling end



For large screws
4.5 / 6.5mm.

LARGE COUNTERSINK

OM 47-0926
7" (178mm)
4.5mm tip



Converts QC end to round end with three flat sides for power drills.

ADAPTOR (POWER DRILL)

OM 45-0002
2 1/2" (64mm)

Note: Taps with quick coupling ends.

Note: Taps are used to prepare threaded path for insertion of bone screws. For the correct instrumentation, please refer to the chart on pages T1-T2 or Section BB

 <p>For cortical screws thread pitch 0.5mm.</p>	 <p>For cortical screws thread pitch 0.6mm.</p>	 <p>For cortical screws thread pitch 1.0mm.</p>	 <p>For cortical screws thread pitch 1.25mm. Fine thread.</p>	 <p>For 3.5 and 4.0mm cancellous screws thread pitch 1.75mm. Coarse thread.</p>
OM 48-0106 2"(51mm) 1.5mm diameter	OM 48-0108 2 1/4"(57mm) 2.0mm diameter	OM 48-0110 4"(102mm) 2.7mm diameter	OM 48-0112 4 1/2"(108mm) 3.5mm diameter	OM 48-0114 4 1/2"(108mm) 3.5mm diameter

Note: Taps with quick coupling ends for 4.5mm cortical and 4.5mm malleolar (shaft) screw.





			 <p>Note: Taps with quick coupling ends calibrated, with centimeter graduations.</p>
OM 48-0116 5"(127mm) 4.5mm diameter	OM 48-0118 5"(127mm) 4.5mm diameter long thread	OM 48-0120 7 1/2"(191mm) 4.5mm diameter extra long	<p>For cortical screws OM 48-0104 7" (178mm) 3.5mm diameter</p> <p>For cortical screws OM 48-0102 7" (178mm) 4.5mm diameter</p> <p>For cancellous screws OM 48-0122 8" (203mm) 6.5mm diameter</p>

Note: For holding quick coupling drills, countersinks, taps and screwdrivers.

Note: To help select the correct size for your needs – refer to our cross-reference chart on pages T1-T2.

 <p>Phenolic handles are autoclavable to 290°F (143°C)</p>		
MINI QUICK COUPLING HANDLE OM 47-0902 4 1/4" (108mm) for mini screw set	SMALL QUICK COUPLING HANDLE OM 47-0904 4 1/2" (114mm) for small and large screw sets	SMALL QUICK COUPLING HANDLE OM 47-0960 3 1/2" (89mm) for small screw set

Note: Used to determine screw length required during internal fracture fixation (mm graduated). Snaps apart for easy cleaning. Important Note: When not in use retract measuring end inside gauge.

			
MINI SCREW DEPTH GAUGE OM 47-0934 4 3/4" (121mm) up to 30mm	SMALL SCREW DEPTH GAUGE OM 47-0936 6 1/4" (159mm) up to 50mm	LARGE SCREW DEPTH GAUGE OM 47-0940 8 3/4" (222mm) up to 100mm	X-LARGE SCREW DEPTH GAUGE OM 47-0935 11" (279mm) up to 120mm

Note: Drill guides and sleeves: used with drills and taps to place accurate holes and protect surrounding tissue.

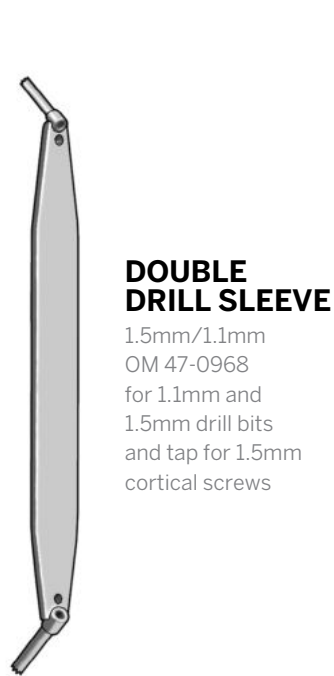

DOUBLE DRILL SLEEVE

1.5mm/1.1mm
OM 47-0968
for 1.1mm and 1.5mm drill bits and tap for 1.5mm cortical screws

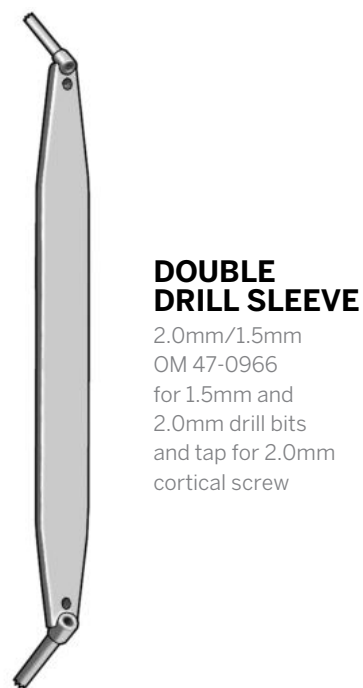

DOUBLE DRILL SLEEVE

2.0mm/1.5mm
OM 47-0966
for 1.5mm and 2.0mm drill bits and tap for 2.0mm cortical screw

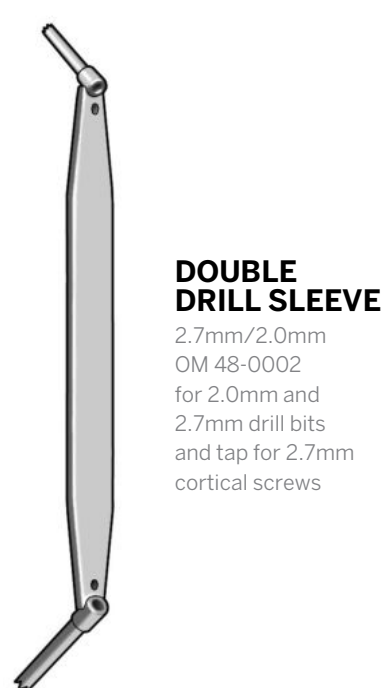

DOUBLE DRILL SLEEVE

2.7mm/2.0mm
OM 48-0002
for 2.0mm and 2.7mm drill bits and tap for 2.7mm cortical screws



DOUBLE DRILL SLEEVE

3.5mm/2.5mm
OM 47-0972
for 2.5mm and 3.5mm drill bits and tap for 3.5mm cortical screws and tap for 4.0mm cancellous screws

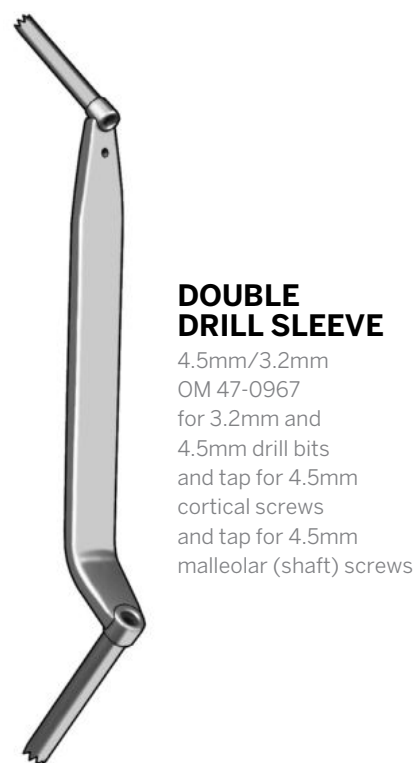

DOUBLE DRILL SLEEVE

4.5mm/3.2mm
OM 47-0967
for 3.2mm and 4.5mm drill bits and tap for 4.5mm cortical screws and tap for 4.5mm malleolar (shaft) screws

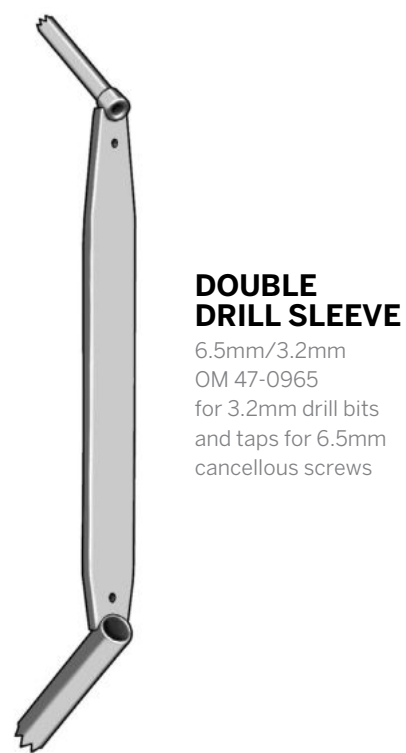

DOUBLE DRILL SLEEVE

6.5mm/3.2mm
OM 47-0965
for 3.2mm drill bits and taps for 6.5mm cancellous screws

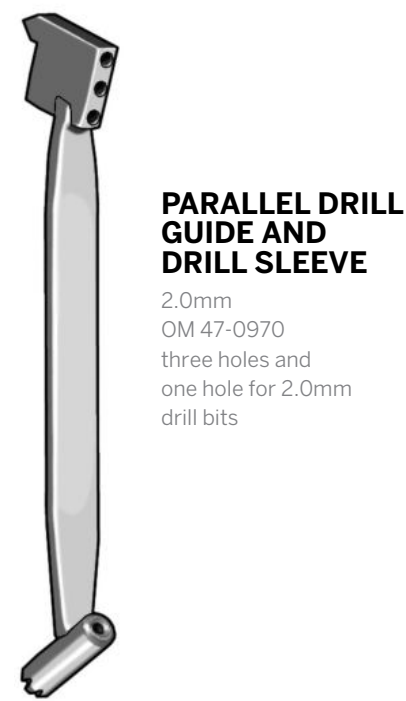

PARALLEL DRILL GUIDE AND DRILL SLEEVE

2.0mm
OM 47-0970
three holes and one hole for 2.0mm drill bits

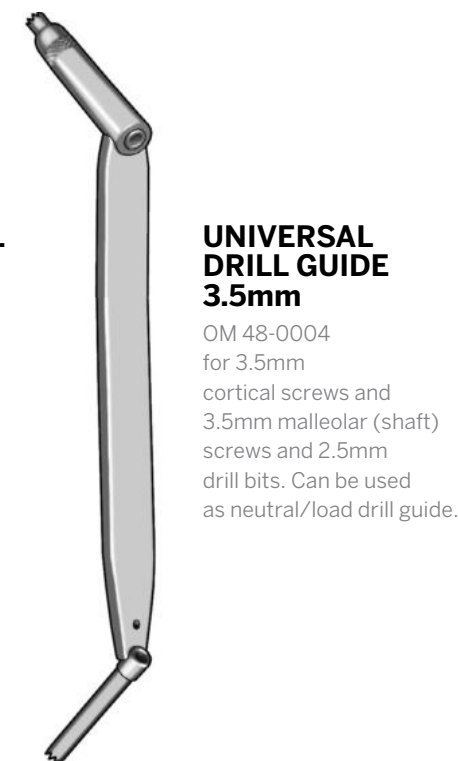

UNIVERSAL DRILL GUIDE 3.5mm

OM 48-0004
for 3.5mm cortical screws and 3.5mm malleolar (shaft) screws and 2.5mm drill bits. Can be used as neutral/load drill guide.



UNIVERSAL DRILL GUIDE 4.5mm

OM 47-0985
for 4.5mm cortical screws and 4.5mm malleolar (shaft) screws and 3.2mm drill bits. Can be used as neutral/load drill guide.



TAP SLEEVE

OM 47-0971
4 1/2" (114mm)
for 3.2mm drill bits

Also can be used as 3.2mm drill bit guide.

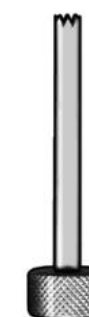

INSERT DRILL SLEEVE

3.5mm/2.7mm
OM 47-0974
for 2.5mm drill bits and for long 3.5mm lag screws



INSERT DRILL SLEEVES

4.5mm/3.2mm
OM 47-0973
for 3.2mm drill bits and for 4.5mm lag screws

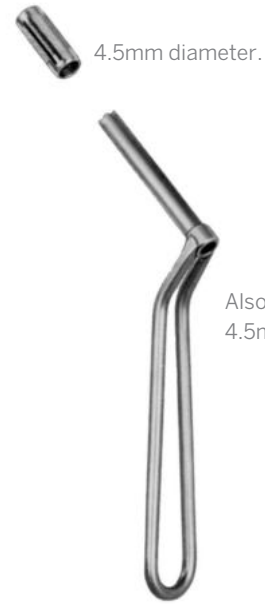

4.5mm diameter.

Also can be used as 4.5mm drill bit guide.

TAP SLEEVE

OM 47-0969
5" (127mm)
with toothed tip and tissue protector sleeve for 4.5mm tap

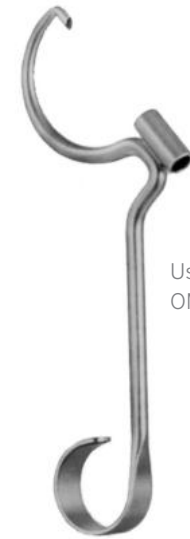

Used with tap sleeve OM 47-0969 or OM 47-0967.

POINTED DRILL GUIDE

OM 47-0975
6" (152mm)
for 4.5mm cortical screws



Drill guide ends are color coded.
green = neutral
gold = load

DRILL GUIDE

2.0mm neutral and load end
OM 47-0977
4 3/4" (121mm)
for 2.0mm drill bit
for 2.7mm cortical screw



DRILL SLEEVE

OM 47-0976
4 1/2" (114mm)
with 40mm long tip
for 3.2mm drill bits
for round hole and semi-tubular plates



DRILL SLEEVE

OM 47-0982
5" (127mm)
with 60mm long tip
for 3.2mm drill bits
for round hole plates



DRILL GUIDE

2.5mm neutral and load end
OM 47-0978
5 1/2" (140mm)
for 2.5mm drill bit
for 3.5mm cortical screw

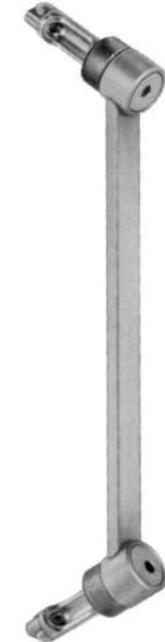

DRILL GUIDE

3.2mm neutral and load end
OM 47-0980
6 1/2" (165mm)
for 3.2mm malleolar (shaft) drill bit
for 4.5mm cortical screw

Note: Screwdrivers: used to place and remove bone screws.



1.5mm

MINI HEXAGONAL SCREWDRIVER

OM 47-0950
2 1/4" (57mm), 1.5mm
quick coupling end
sleeve included

OM 47-0959
screw holding
sleeve only



MINI CRUCIFORM SCREWDRIVER BIT

OM 45-0004
2 1/2" (64mm)
quick coupling end



2.5mm

SMALL HEXAGONAL SCREWDRIVER

OM 47-0953
4" (102mm), 2.5mm
quick coupling end

OM 47-0955
screw holding
sleeve only
for OM 47-0953



3.5mm

HEXAGONAL SCREWDRIVER SHAFT (PELVIC)

OM 47-0961
6 1/2" (165mm), 3.5mm
quick coupling end
with notch

OM 47-0983
sleeve only



3.5mm

STAR DRIVE SCREWDRIVER SHAFT

OM SYN 314467 T8 QC Self retain 105mm
OM SYN 314116 T15 QC Self retain 100mm
OM SYN 314119 T25 QC Self retain 165mm



2.5mm

HEXAGONAL SCREWDRIVER SHAFT

OM 48-0348
5 1/2" (140mm), 2.5mm
quick coupling end
with notch

OM 48-0365
sleeve only



2.5mm

HEXAGONAL SCREWDRIVER SHAFT (PELVIC)

OM 47-0951
6 1/2" (165mm), 2.5mm
quick coupling end
with notch

OM 48-0365
sleeve only



3.5mm

LARGE HEXAGONAL SCREWDRIVER

OM 47-0954
4 1/2" (114mm), 3.5mm
quick coupling end



This is the sleeve for
OM 48-0349
OM 48-0353
OM 47-0961

SCREWDRIVER SLEEVE

OM 47-0983
5" (127mm)



This is the sleeve for
OM 47-0951
OM 48-0364
OM 48-0368
OM 48-0348

SCREWDRIVER SLEEVE

OM 48-0365
3" (76mm)

Refer to chart on page T1 and T2 for Master Guide, Screws, Drill Bits, Taps, Instruments



HEXAGONAL SCREWDRIVER

OM 48-0670
7 5/8" (194mm) 1.5mm



HEXAGONAL SCREWDRIVER

OM 47-0952
7 3/4" (197mm), 2.5mm screwdriver with sleeve

OM 47-0955
screw holding sleeve only for OM 47-0952

OM 47-0956
screwdriver only for OM 47-0952



CRUCIFORM SCREWDRIVER

OM 47-0957
7 1/2" (191mm), 1.5 / 2.5mm screwdriver with sleeve

OM 47-0959
screw holding sleeve only for OM 47-0957

OM 47-0958
screwdriver only for OM 47-0957



Phenolic handles is autoclavable to 290°F (143°C)

SINGLE SLOT SCREWDRIVER

OM 48-0355
6 3/4" (172mm) with phenolic handle

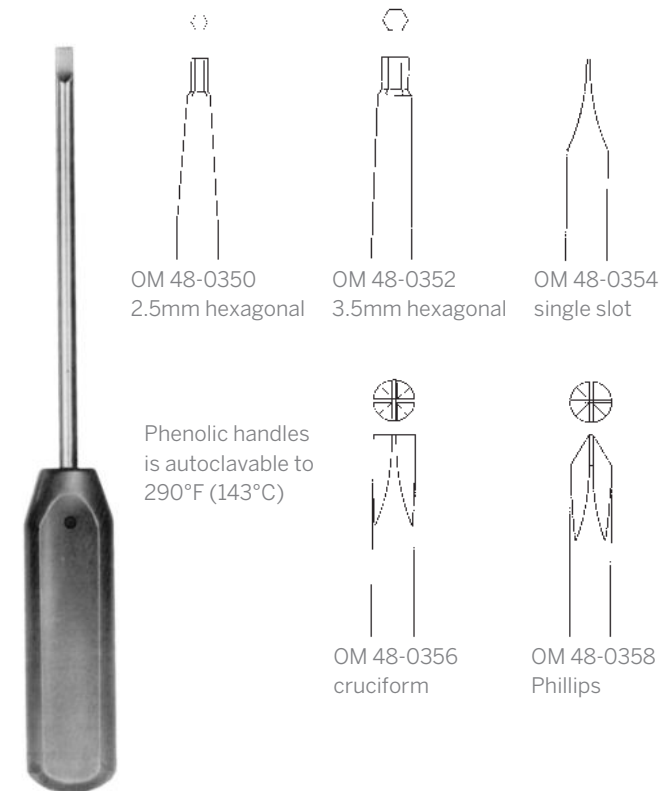

OM 48-0350
2.5mm hexagonal

OM 48-0352
3.5mm hexagonal

OM 48-0354
single slot

Phenolic handles is autoclavable to 290°F (143°C)

OM 48-0356
cruciform

OM 48-0358
Phillips

SCREWDRIVER

10" (254mm) with phenolic handle



3.5mm

STAR DRIVER

OM 96-0164
9" (228mm)
silicone handle fits 3.5/4.0mm screws



HEXAGONAL SCREWDRIVER

OM 48-0368
8" (203mm)
2.5mm with notch screwdriver only



HEXAGONAL SCREWDRIVER (PELVIC)

OM 48-0364
10 1/2" (267mm)
2.5mm with notch screwdriver only



3.5mm

HEXAGONAL SCREWDRIVER

OM 48-0349
10" (254mm), 3.5mm with notch



3.5mm

HEXAGONAL SCREWDRIVER (PELVIC)

OM 48-0353
12" (305mm), 3.5mm with notch



SCREWDRIVER SET (A/O CONNECTION)

OM 48-0481
complete set with sterilization case

OM 48-0482
sterilization case only
8 1/2" X 4 1/4" X 2"
(216mm X 114mm X 51mm)



SCREWDRIVER HANDLE

OM 48-0483
5 1/2" (140mm) with key
cannulation 1/4" (6.3mm)
Allows K-Wire and pins to be inserted
with Jacobs chuck OM 48-0478.

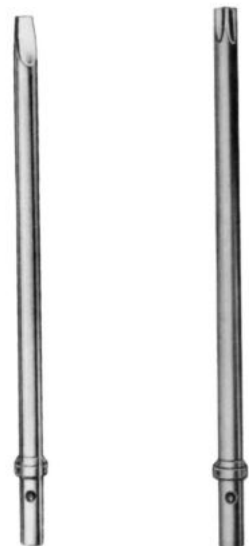

OM 48-0484
5 1/2" (140mm)
single slot

OM 48-0485
5 1/2" (140mm)
cruciform



To check fracture and
remove ingrown tissue.

SHARP HOOK

OM 47-0880
6" (152mm)



To hold all sizes of
OrthoMed bone screws.

**SELF RETAINING
SCREW HOLDING FORCEPS**

OM 47-0930
3 1/2" (89mm)



**SELF RETAINING
SCREW HOLDING FORCEPS**

OM 45-0208 for 1.5mm to 2.7mm screws
OM 45-0210 for 3.5mm to 6.5mm screws



JACOBS UNIVERSAL CHUCK

OM 48-0488
3" with key
cannulation 1/4" (6.3mm)
Allows K-Wire and pins to be inserted
with Jacobs chuck.



OM 48-0486
5 1/2" (140mm)
Phillips



OM 48-0487
5 1/2" (140mm)
small Phillips



OM 48-0489
5 1/2" (140mm)
3.5mm hexagonal



OM 48-0490
5 1/2" (140mm)
2.5mm hexagonal

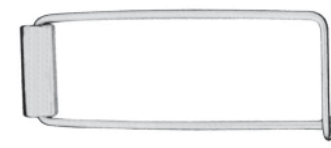

PLATE HOLDING CLIP

OM 47-0962 2.0mm
OM 47-0963 2.7mm
OM 47-0964 3.5mm



**DRILL SLEEVE
FOR TENSION DEVICE**

OM 47-0909
2" (51mm)
span: 8mm / 16mm
for 3.2mm drill bit



TENSION DEVICE

OM 47-0910
2 1/2" (64mm)
span: 8mm



For standard and small plates

TENSION DEVICE ARTICULATED

OM 47-0911
3 1/2" (89mm)
span: 20mm

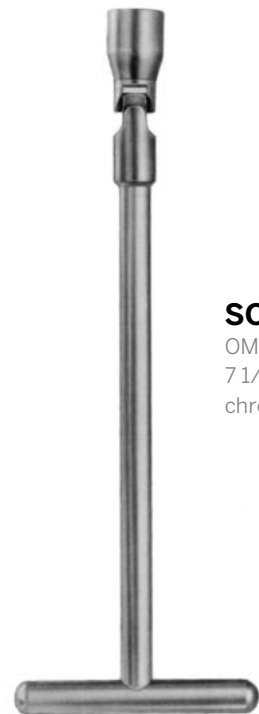

SOCKET WRENCH

OM 47-0912
7 1/2" (191mm), 11mm
chrome vanadium



COMBINATION WRENCHES

		Overall Length
OM 85-0006	6mm	3 1/2"
OM 85-0008	8mm	4 1/2"
OM 85-0010	10mm	5 1/2"
OM 85-0012	11mm	6"
OM 85-0014	12mm	7"
OM 85-0016	13mm	7"
OM 85-0018	14mm	7 3/4"
OM 85-0020	15mm	8 1/2"
OM 85-0022	1/4" (6mm)	3 1/2"
OM 85-0024	5/16" (8mm)	4 1/2"
OM 85-0026	3/8" (10mm)	5 1/2"
OM 85-0028	7/16" (11mm)	6"
OM 85-0030	1/2" (13mm)	7"
OM 85-0032	9/16" (14mm)	7 3/4"
OM 85-0034	5/8" (16mm)	8 1/2"

OPEN END WRENCHES

Stainless steel

		Overall Length
OM 85-0036	6x7mm	4 7/8" (125mm)
OM 85-0038	8x9mm	5 1/2" (141mm)
OM 85-0040	10x11mm	6 1/4" (159mm)
OM 85-0042	12x13mm	7" (178mm)
OM 85-0044	14x15mm	7 1/2" (192mm)
OM 85-0046	16x17mm	8 1/4" (210mm)
OM 85-0048	19x22mm	9 1/2" (243mm)
OM 85-0050	24x27mm	10 1/2" (267mm)
OM 85-0052	28x29mm	10 7/16" (265mm)
OM 85-0054	30x32mm	9 9/16" (246mm)
OM 85-0056	19x24mm	11 3/8" (288mm)
OM 85-0058	1/4"x5/16" (6mmx24mm)	4 7/8" (125mm)
OM 85-0060	3/8"x7/16" (10mmx11mm)	6 1/4" (159mm)
OM 85-0062	1/2"x9/16" (13mmx14mm)	7" (178mm)
OM 85-0064	5/8"x11/16" (16mmx18mm)	8 1/4" (210mm)
OM 85-0066	3/4"x13/16" (19mmx21mm)	8 7/8" (225mm)
OM 85-0068	7/8"x15/16" (22mmx24mm)	10 1/4" (261mm)
OM 85-0070	1"x1 1/16" (25mmx27mm)	10 3/8" (264mm)
OM 85-0072	1 1/8"x1 1/4" (29mmx32mm)	10 5/8" (270mm)



For tightening 8mm nuts.

WRENCH

OM 47-0914
5" (127mm)

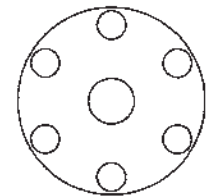
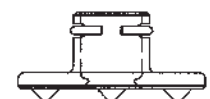

SPIKED DISC

OM 47-0921



BALL SPIKE

Straight
OM 47-0906
12" (305mm)



Stainless Steel designed for repeated autoclaving over years of use.

HEX KEYS

Stainless Steel, inch sizes,
L Pattern, standard length

OM 85-0200	1/16"
OM 85-0205	5/64"
OM 85-0210	3/32"
OM 85-0215	7/64"
OM 85-0220	1/8"
OM 85-0225	9/64"
OM 85-0230	5/32"
OM 85-0235	3/16"
OM 85-0240	7/32"
OM 85-0245	1/4"
OM 85-0250	5/16"
OM 85-0255	3/8"

OM 85-0260
10 Piece Set (includes one of each of 1/16"-1/4")

OM 85-0265
12 Piece Set (includes one of each)

HEX KEYS

Stainless Steel, metric sizes,
L pattern, standard length

OM 85-0270	1.5mm
OM 85-0275	2.0mm
OM 85-0280	2.5mm
OM 85-0285	3.0mm
OM 85-0290	3.5mm
OM 85-0295	4.0mm
OM 85-0300	4.5mm
OM 85-0305	5.0mm
OM 85-0310	6.0mm
OM 85-0315	8.0mm
OM 85-0320	10.0mm

OM 85-0325
9 Piece Set (includes one of each of 1.5mm-6.0mm)

OM 85-0330
11 Piece Set (includes one of each)

BENDING TEMPLATES

Anodized aluminum
Color-coded

 OM 47-0944 2 1/2" for small plates

 OM 47-0945 3 1/2" for small plates

 OM 47-0941 3 1/2" 5 holes

 OM 47-0942 4 1/2" 7 holes

 OM 47-0943 6" 9 holes

To simulate required plate bending.

BENDING TEMPLATES

Anodized aluminum

 OM 45-0126 2 1/2" 5 holes 3.5mm

 OM 45-0127 3 1/2" 7 holes 3.5mm

 OM 45-0128 4 1/2" 9 holes 3.5mm

 OM 45-0129 6" 12 holes 3.5mm

 OM 45-0118 3 1/4" 5 holes 4.5mm

 OM 45-0120 4 3/4" 7 holes 4.5mm

 OM 45-0122 6" 9 holes 4.5mm

 OM 45-0124 8" 12 holes 4.5mm

BENDING TEMPLATES

Anodized aluminum
Reconstruction plates



OM 47-0946
22 holes
8" (203mm) length X 2 1/2" (64mm) height
3.5mm



OM 47-0947
22 holes
10 1/2" (267mm) straight
3.5mm



OM 47-0948
16 holes
10" (254mm) straight
4.5mm

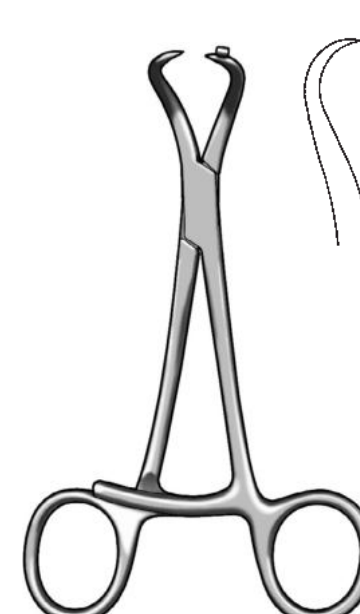

BONE HOLDING FORCEPS

OM 45-0304
5 1/2" (140mm)
with 1.6mm drill guide

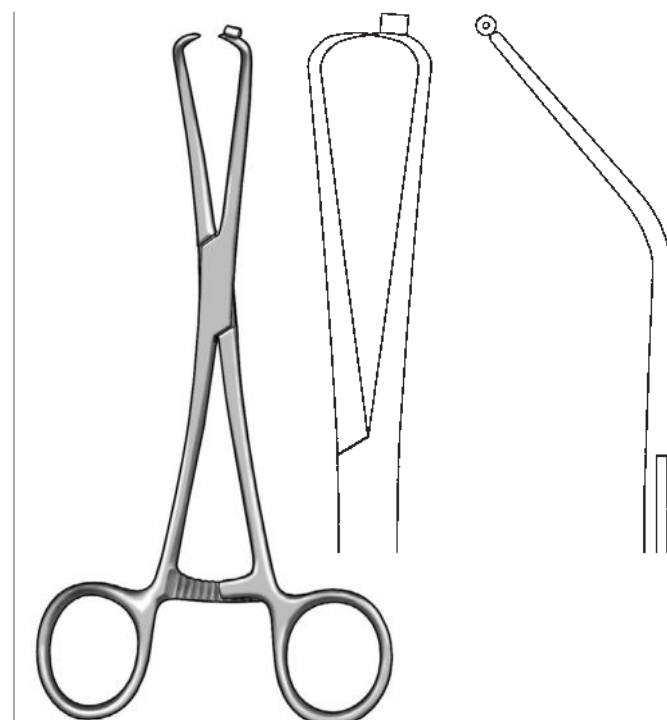

BONE HOLDING FORCEPS

OM 45-0302
6 3/4" (171mm)
with 0.9mm drill guide



For positioning small bone plates.

PLATE AND BONE HOLDING FORCEPS

OM 47-0138 4 3/4" (121mm)

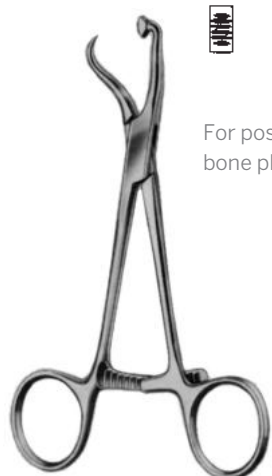

For positioning mini bone plates.

PLATE AND BONE HOLDING FORCEPS

OM 47-0139 4 3/4" (121mm)
1 pointed tip

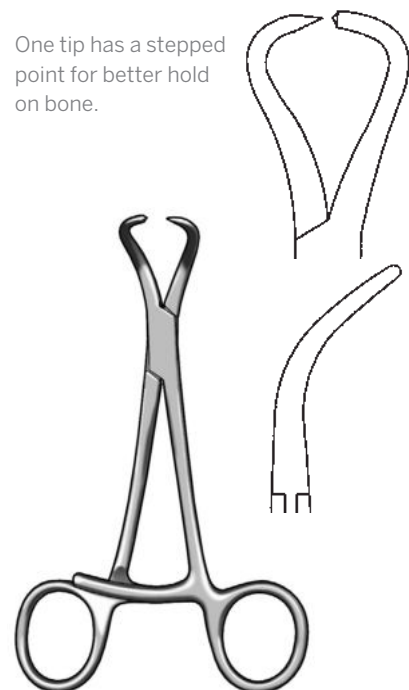

One tip has a stepped point for better hold on bone.

BONE REDUCTION FORCEPS

OM 47-0137 5 1/4" (133mm) curved

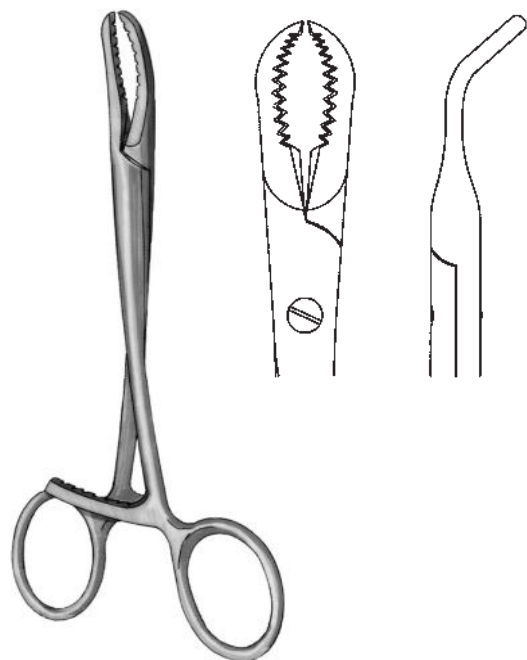

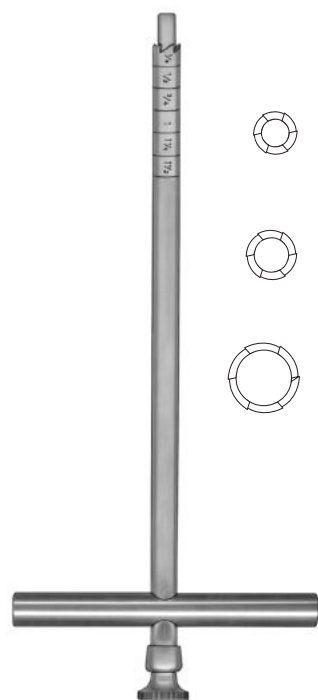

BONE REDUCTION FORCEPS

OM 47-0128 5 1/2" (140mm) small curved
ratchet length: 1 1/8"



i.d = inside diameter
o.d. = outside diameter

-  small
3mm i.d / 5mm o.d.
-  medium
4mm i.d / 5mm o.d.
-  large
6mm i.d / 8mm o.d.

Designed for bone biopsy. Also facilitates removal of broken bone screws.

MICHELE TREPHINE

OM 48-0239 small
OM 48-0240 medium
OM 48-0241 large

Note: Bending instruments: To avoid weakening of plates, do not bend or twist sharply. Never reverse bend or bend or twist at a plate hole.



MINI PLATE BENDING IRON

OM 47-0917 4 3/4" (121mm)
for mini and finger plates

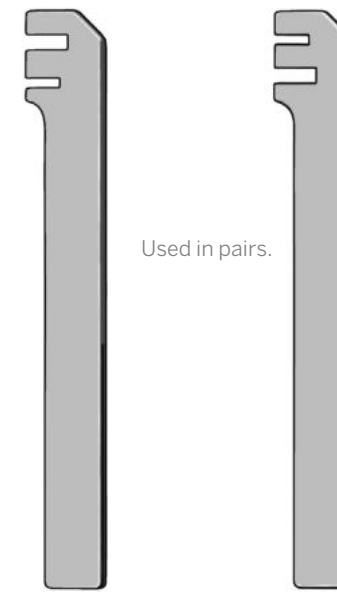

Used in pairs.

OM 47-0916

OM 47-0915

SMALL PLATE BENDING IRONS

5 1/2" (140mm)
for 2.7mm and 3.5mm plates



STANDARD PLATE BENDING IRON

OM 47-0918 9 1/2" (241mm)
for standard plates with 4 holes

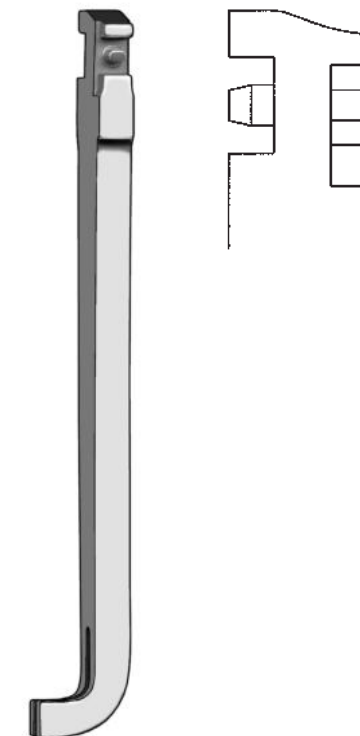
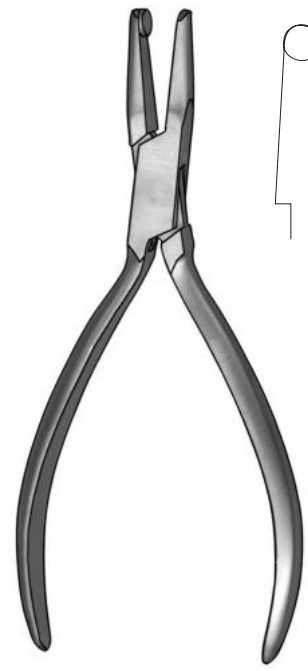

PLATE BENDING IRON

OM 47-0919
for 3.5mm and 4.5mm plates



MINI PLATE BENDING PLIERS

OM 48-0244
5" (127mm)
for 1.5mm and 2.0mm plates

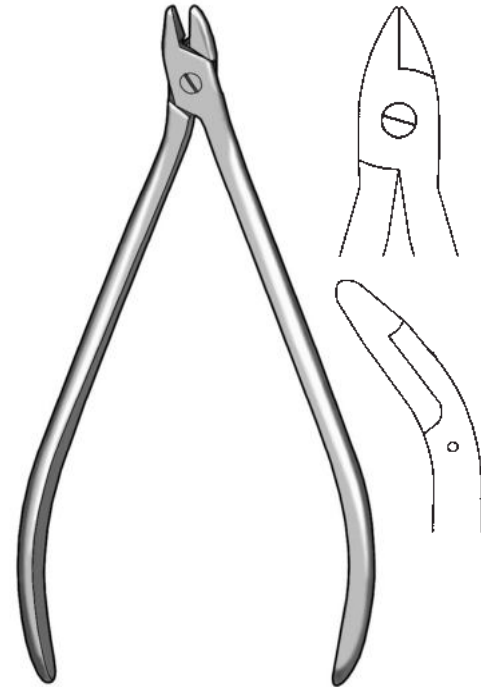

BENDING PLIERS

OM 47-0931
5 1/2" (140mm)
for 1.5mm and 2.0mm plates

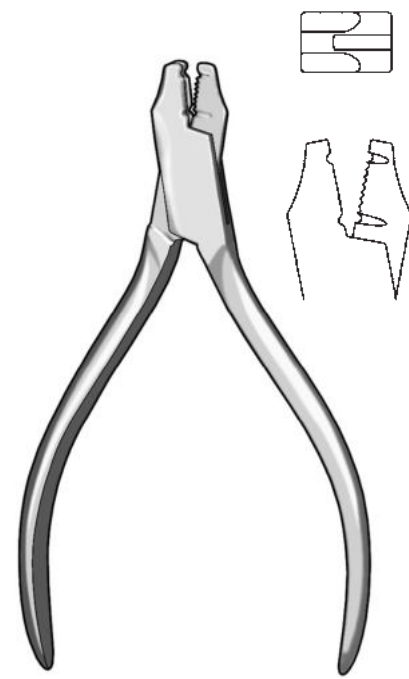

BENDING PLIERS

OM 49-0724
Bends mini plates and up to
1.1mm (.045") K-Wire to 90° angle

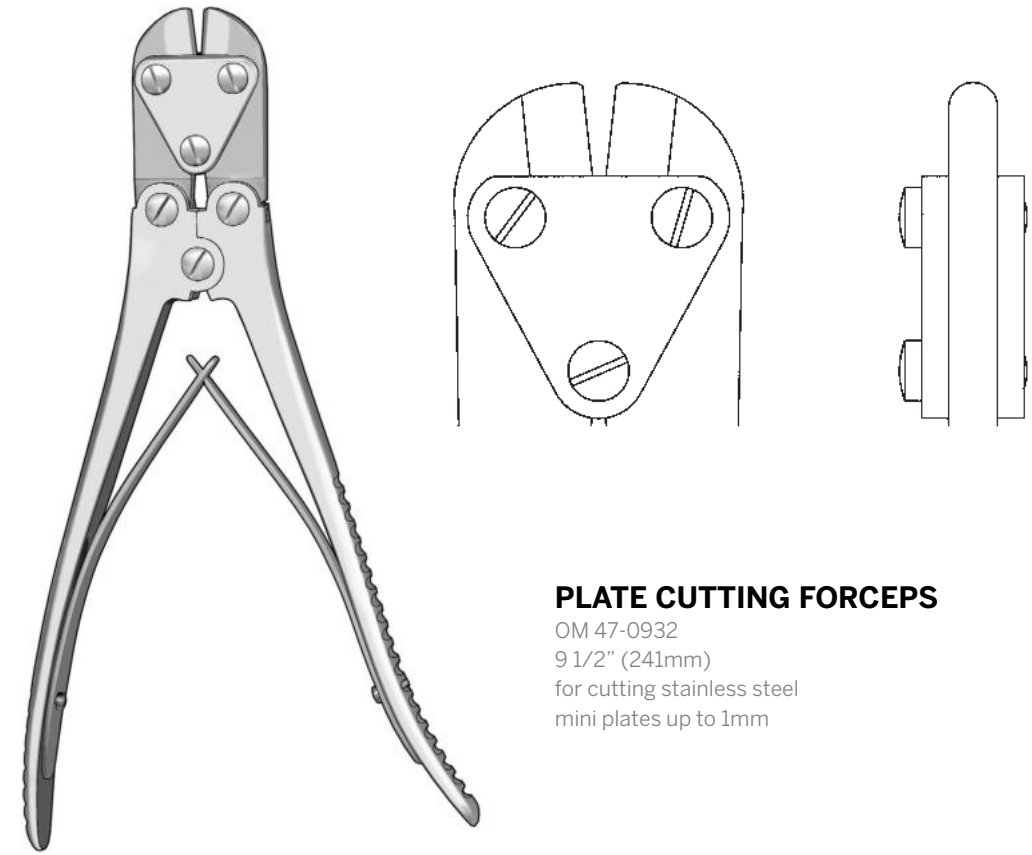

PLATE CUTTING FORCEPS

OM 47-0932
9 1/2" (241mm)
for cutting stainless steel
mini plates up to 1mm



SMALL PLATE BENDING PLIERS

OM 47-0925
8 3/4" (222mm)
for 2.7mm and 3.5mm plates

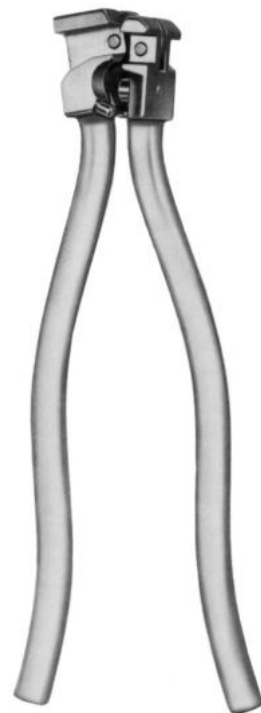

PLATE BENDING PLIERS

OM 47-0927
10" (254mm)
for reconstruction plates



PLATE BENDING PLIERS

OM 47-0928
10" (254mm)
includes two anvils for narrow
and broad plates

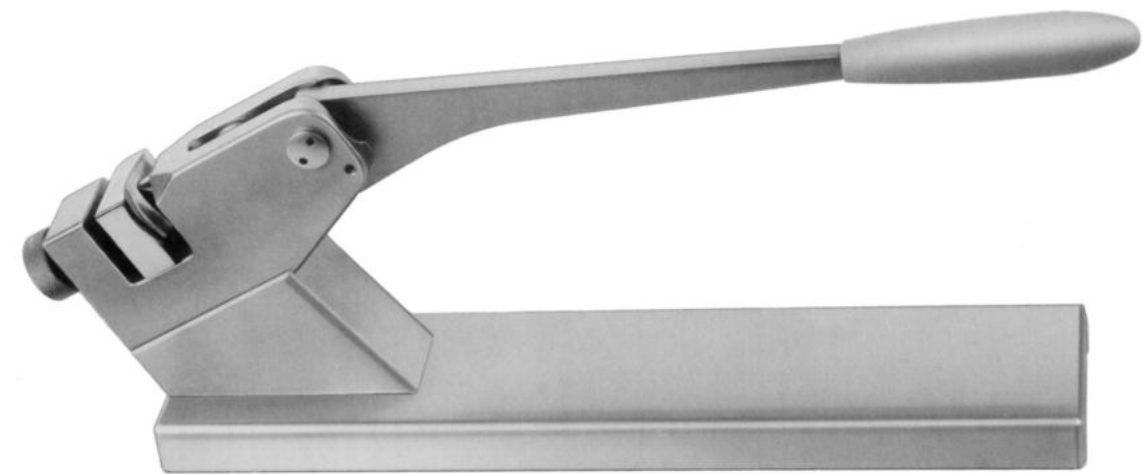
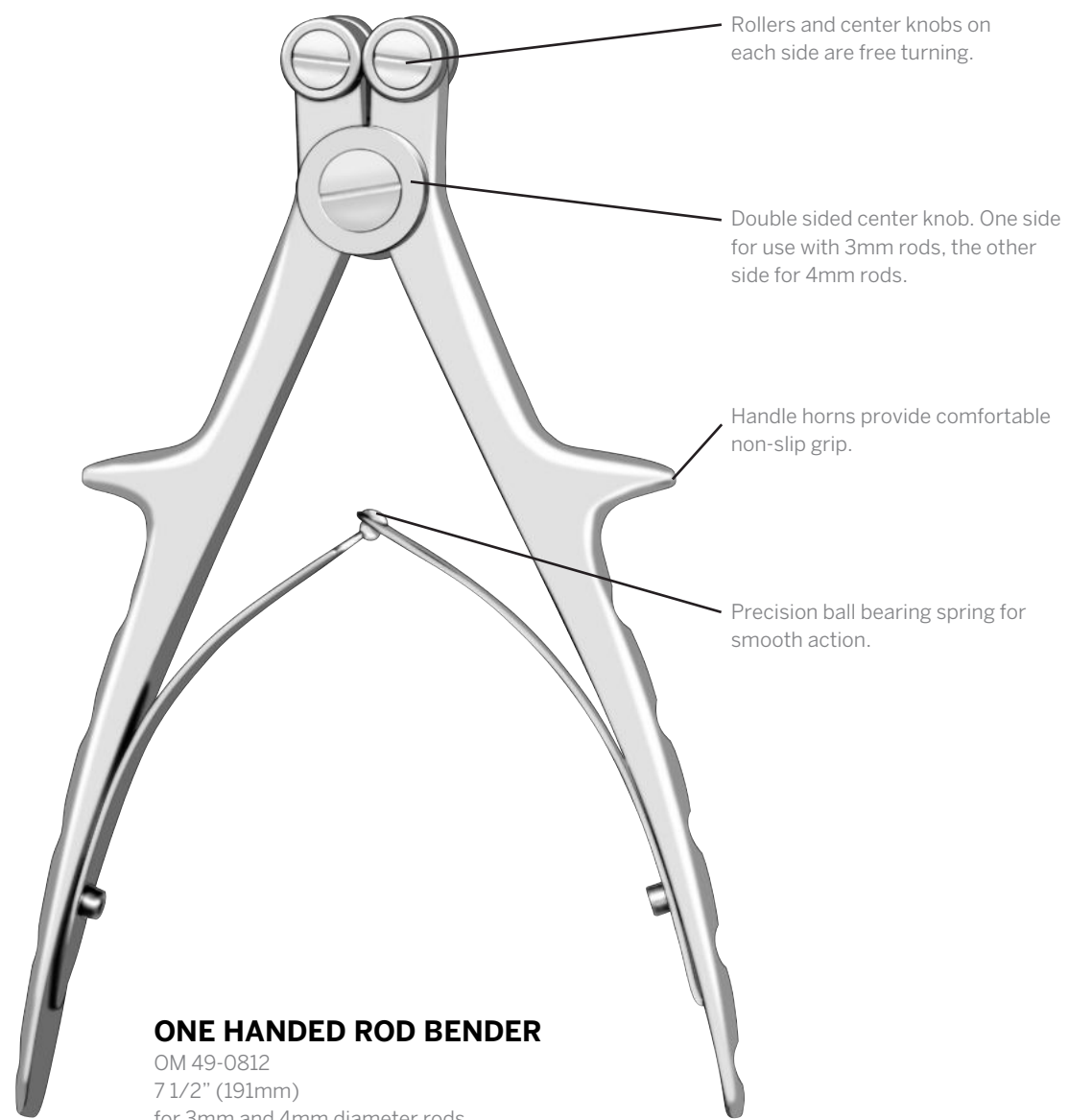
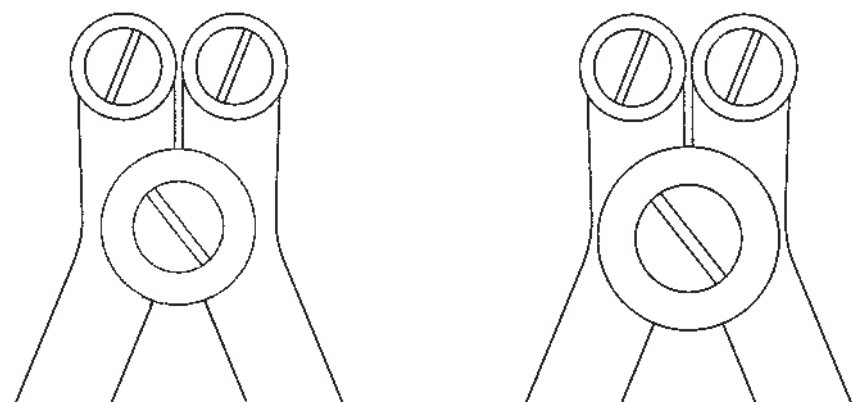

PLATE BENDING PRESS

OM 47-0929
17" (305mm)

Note: One-handed rod bender: Easily bends 3mm and 4mm rods.



ONE HANDED ROD BENDER
 OM 49-0812
 7 1/2" (191mm)
 for 3mm and 4mm diameter rods

Note: Universal Rod Bender: Bends any size rod (up to 7mm) to three different angles without using a separate reduction ring.

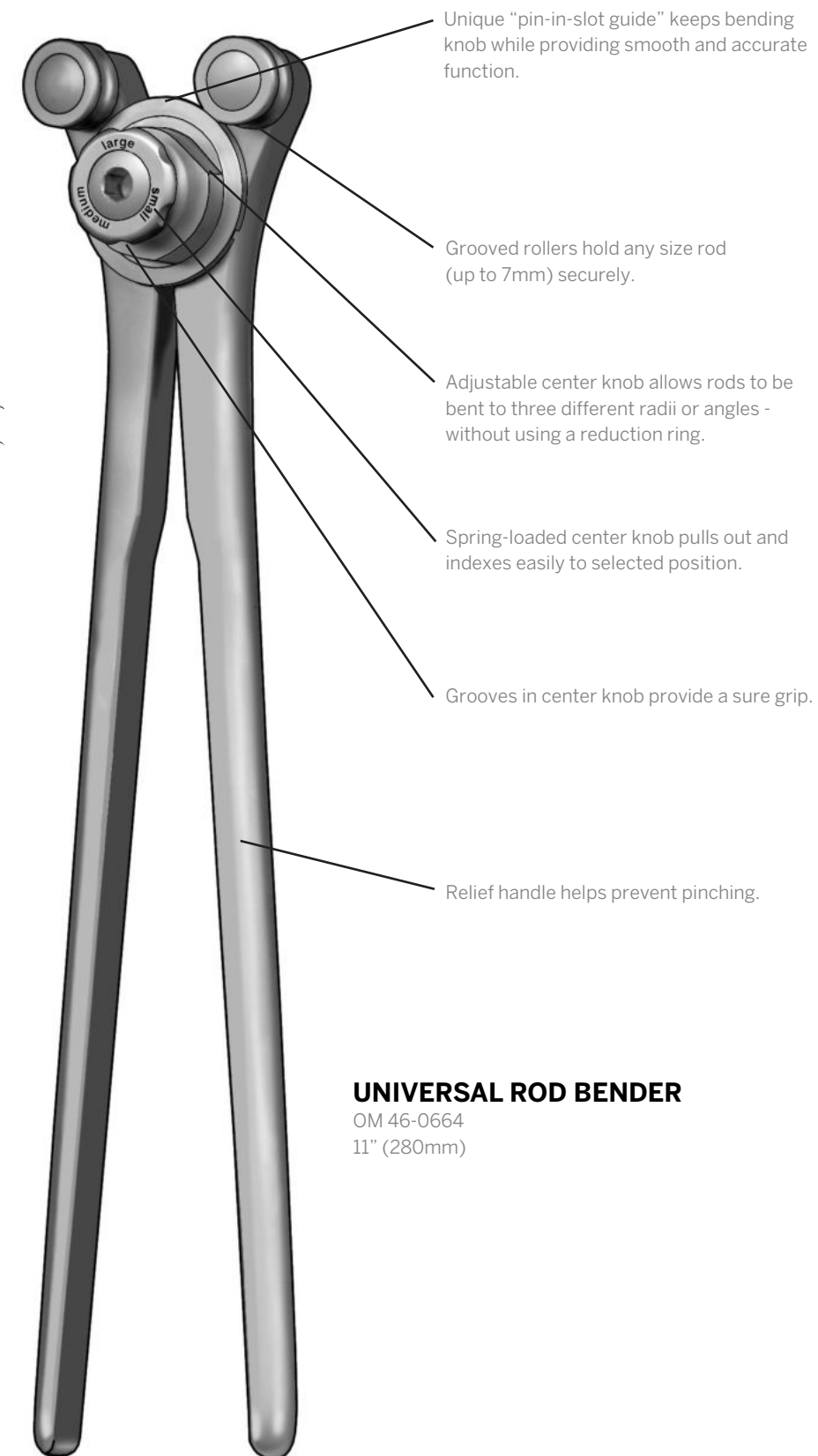
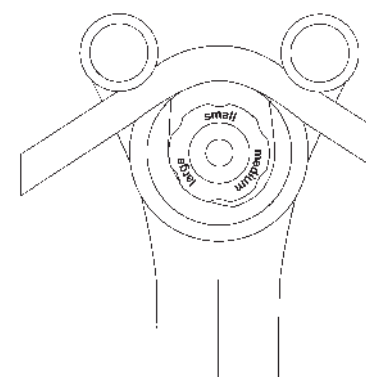

UNIVERSAL ROD BENDER
 OM 46-0664
 11" (280mm)

IMPORTANT NOTE:
 Before bending, make sure that rod is properly seated (ie: flat and even) on the center knob and between both roller grooves.



SCREW EXTRACTION SET

OM 87-0000
Complete

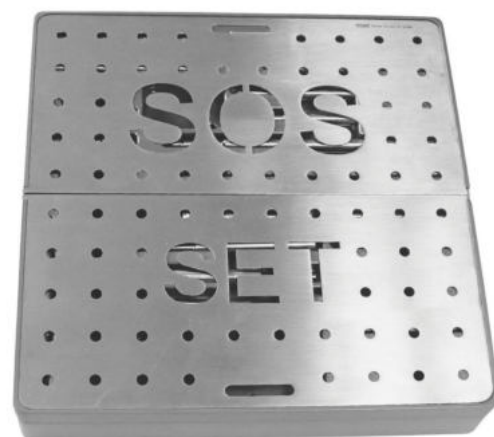

TRAY (EMPTY)

OM 87-0005



LISTING FOR SET: OM 87-0000 SCREW-EXTRACTION - SET COMPLETE

Reference Number	Product - Description	
OM 87-0005	AL-Tray for Screw Extraction OM 87-0005	1Pcs.
OM 87-0010	Conical Extraction Screw for 1.5 / 2.0mm Screws	1Pcs.
OM 87-0015	Conical Extraction Screw for 2.7 / 3.5 / 4.0mm Screws	1Pcs.
OM 87-0020	Conical Extraction Screw for 4.5 / 5.0 / 6.5 / 7.0mm Screws	1Pcs.
OM 87-0030	Extraction Bolt for 1.5mm Screws	1Pcs.
OM 87-0035	Extraction Bolt for 2.0mm Screws	1Pcs.
OM 87-0038	Extraction Bolt for 2.7mm Screws	1Pcs.
OM 87-0040	Extraction Bolt for 3.5 / 4.0mm Screws	1Pcs.
OM 87-0043	Extraction Bolt for 4.5mm Screws	1Pcs.
OM 87-0045	Extraction Bolt for 5.0 / 6.5 / 7.0mm Screws	1Pcs.
OM 87-0050	Hollow Reamer for 1.5mm Screws	1Pcs.
OM 87-0052	Hollow Reamer for 2.0mm Screws	1Pcs.
OM 87-0054	Hollow Reamer for 2.7mm Screws	1Pcs.
OM 87-0056	Hollow Reamer for 3.5 / 4.0mm Screws	1Pcs.
OM 87-0058	Hollow Reamer for 4.5mm Screws	1Pcs.
OM 87-0059	Hollow Reamer for 5.0 / 6.5 / 7.0mm Screws	1Pcs.
OM 87-0064	Spare Reamer (Reamer Tube) for Hollow Reamer 1.5mm (used for 1.5mm Screws)	1Pcs.
OM 87-0065	Spare Reamer (Reamer Tube) for Hollow Reamer 2.0mm (used for 2.0mm Screws)	1Pcs.
OM 87-0066	Spare Reamer (Reamer Tube) for Hollow Reamer 2.7mm (used for 2.7mm Screws)	1Pcs.
OM 87-0067	Spare Reamer (Reamer Tube) for Hollow Reamer 3.5 / 4.0mm (used for 3.5 / 4.0mm Screws)	1Pcs.
OM 87-0069	Spare Reamer (Reamer Tube) for Hollow Reamer 4.5mm (used for 4.5mm Screws)	1Pcs.
OM 87-0071	Spare Reamer (Reamer Tube) for Hollow Reamer 5.0 / 6.5 / 7.0mm (used for 5.0 / 6.5 / 7.0mm Screws)	1Pcs.
OM 47-0880	Sharp Hook, Length 155mm	1Pcs.
OM 49-0272	Mini Lexer Gouge, 4mm	1Pcs.
OM 49-0274	Mini Lexer Gouge, 6mm	1Pcs.
OM 49-0277	Mini Lexer Gouge, 10mm	1Pcs.
OM 87-0080	Screw Holding Forceps 20.5cm / 8"	1Pcs.
OM 47-0960L	T-Handle, Large with AO-Quickcoupling Length 160mm	1Pcs.
OM 87-0090	Template for use Broken Screw-Extraction Instruments (Guide Manual for Use)	1Pcs.