

MALLETS, TAMPS AND IMPACTORS



SECTION K



Mallets exert force on osteotomes, chisels and gouges.
Tamps wedge bone graft into place.

CONTENTS

| | |
|-----------------------|------|
| Mallets | 1-6 |
| Tamps | 7-8 |
| Impactors and Drivers | 8-10 |

ORTHO+MED
The Surgical Instrument Specialists

Note: Lead filled mallets should only be used to strike flat surfaces. Do not use to hit sharp objects as doing so can cause lead to flake off.

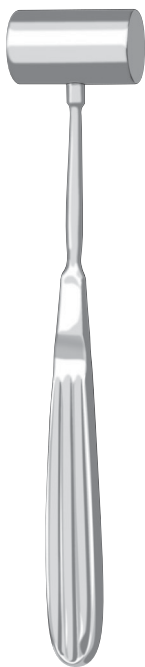

OM 49-0765
7" (178mm)
solid stainless steel
weight: 4 oz. (120 grams)
head weight: 3 oz. (80 grams)
head diameter: 20mm

MINI Mallet



OM 49-0761
7½" (191mm)
solid stainless steel
weight: 7 oz. (200 grams)
head weight: 3 oz. (80 grams)
head diameter: 19mm

OM 46-0660
8" (203mm)
brass head
stainless steel handle
weight: 9 oz. (260 grams)
head weight: 5 oz. (150 grams)
head diameter: 25mm

LUCAE BONE Mallet

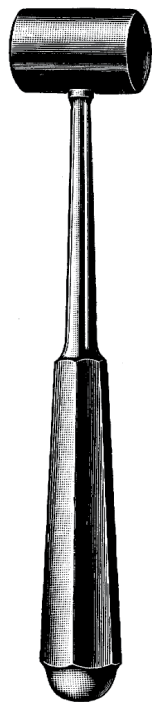

OM 46-0656
7¾" (195mm)
lead filled and faced
weight: 7 oz. (200 grams)
head weight: 5 oz. (150 grams)
head diameter: 22mm

Mallet #49

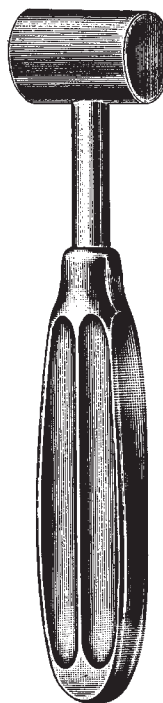

OM 46-0661
7½" (191mm)
lead filled and faced
weight: 10 oz. (285 grams)
head weight: 7 oz. (200 grams)
head diameter: 25mm

GERZOG BONE Mallet

MALLETS



Useful for hand surgery and in areas where access is limited.

Autoclavable to 290° F (143° C).

OM 49-0764
8" (203mm)
with black plastic handle
weight: 7 oz. (200 grams)
head weight: 3 oz. (80 grams)
head diameter: 18mm x 18mm
(square contact surface)
7mm (round contact surface)

NARROW TIP Mallet



OM 49-0760
8" (203mm)
solid stainless steel
weight: 7 oz. (200 grams)
head weight: 5 oz. (150 grams)
head diameter: 30mm

LUCAE BONE Mallet



Autoclavable to 250° F (121° C).

OM 46-0662
7 ½" (191mm)
with two replaceable nylon caps
anodized aluminum handle
weight: 7 oz. (200 grams)
head weight: 4 oz. (120 grams)
head diameter: 25mm

Mallet with Nylon Caps

Lightweight

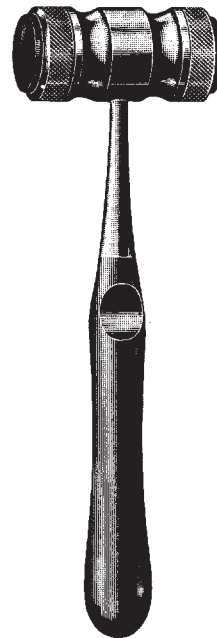

Autoclavable to 250° F (121° C).

OM 46-0657
7 ½" (191mm)
with replaceable nylon caps
weight: 11 oz. (315 grams)
head weight: 6 oz. (170 grams)
head diameter: 20mm

MEAD Mallet

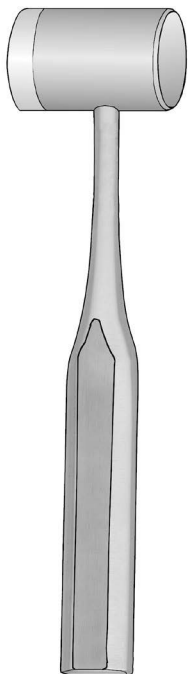

Autoclavable to
250° F (121° C).

OM 46-0686
7½" (191mm)
weight: 9 oz. (260 grams)
head weight: 5 oz. (150 grams)
head diameter: 26mm

OM 46-0687
7½" (191mm)
weight: 12 oz. (340 grams)
head weight: 8 oz. (240 grams)
head diameter: 30mm

COMBINATION Mallet

With one nylon cap and one solid stainless side



OM 55-0400
7 ½" (191mm)
weight: 8 oz. (240 grams)
head weight: 4 oz. (120 grams)
head diameter: 19mm
ball pean diameter: 16mm

OM 55-0401
9" (229mm)
weight: 1 lb. (450 grams)
head weight: 8 oz. (240 grams)
head diameter: 25mm
ball pean diameter: 22mm

CLOWARD-STYLE Mallet

Solid stainless steel



OM 49-0763
7" (178mm)
solid stainless steel
weight: 1 lb. 2oz (500 grams)
head weight: 8oz (240 grams)
head diameter: 30mm

ORTHOPEDIC Mallet

Short handle, lightweight



*Head is brass filled
and should only be
used to strike flat
surfaces.*

OM 46-0658
7¾" (195mm)
weight: 1 lb. 7 oz. (650 grams)
head weight: 1 lb. 4 oz. (570 grams)
head diameter: 38mm

KIRK Mallet

MALLETS



OM 49-0762
7 ½" (191mm)
solid stainless steel
weight: 2 lbs. (900 grams)
head weight: 1 lb. 5 oz. (600 grams)
head diameter: 38mm

ORTHOPEDIC MALLET
Heavyweight, short handle

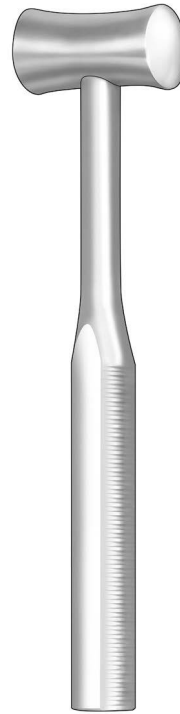

OM 49-0766
9" (229mm)
aluminum alloy handle
weight: 15 oz. (420 grams)
head weight: 9 oz. (260 grams)
head diameter: 30mm

BERGMAN MALLET

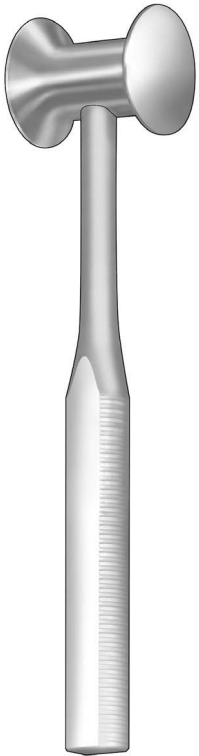

OM 49-0767
9 ½" (241mm)
aluminum alloy handle
weight: 1 lb. 1 oz. (470 grams)
head weight: 11 oz. (310 grams)
head diameter: 45mm

BERGMAN MALLET

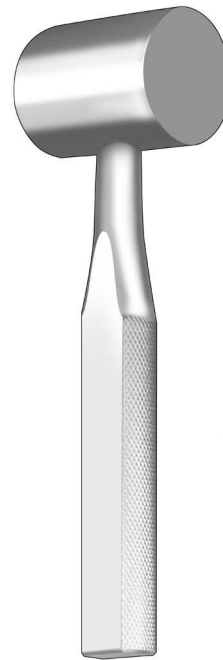

OM 46-0663
7 ½" (191mm)
aluminum handle
weight: 2 lbs. (900 grams)
head weight: 1 lb. 4 oz. (570 grams)
head diameter: 40mm

HEATH MALLET
Heavyweight



Also known as dead blow mallet.

Grooved phenolic handle for comfortable grip. Autoclavable to 250° F (121° C).

OM 46-0690
 11 ½" (292mm)
 weight: 1 lb. 5 oz. (600 grams)
 head weight: 10 oz. (285 grams)
 head diameter: 32mm
 dead blow mallet with black plastic handle, one nylon cap and one stainless steel side

REPROCUSSION FREE MALLET



OM 46-0667
 10 ½" (267mm)
 solid stainless steel
 weight: 3 lbs. (1360 grams)
 head weight: 2 lbs. (900 grams)
 head diameter: 48mm

ORTHOPEDIC MALLET

Heavyweight



Grooved phenolic handle for comfortable and safe grip. Autoclavable to 290° F (143° C).

OM 46-0688
 10" (254mm)
 weight: 1 lb. 11 oz. (765 grams)
 head weight: 1 lb. (455 grams)
 head diameter: 35mm

BLACK PLASTIC HANDLE MALLET



OM 46-0666
 10 ¾" (273mm)
 solid stainless steel
 weight: 2 lbs. (900 grams)
 head weight: 1 lb. (455 grams)
 head diameter: 32mm

ORTHOPEDIC MALLET

Lightweight

MALLETS



Grooved phenolic handle for comfortable and safe grip. Autoclavable to 290° F (143° C).

OM 46-0689
11" (280mm)
weight: 2 lbs. 9 oz. (1160 grams)
head weight: 2 lbs. (900 grams)
head diameter: 45mm

BLACK PLASTIC Mallet



3 lb Mallet

OM 46-0697
10 1/2" (267mm) overall length
8 3/4" (222mm) knurled handle
37mm head diameter
70mm head length

5 lb Mallet

OM 46-0698
11" (280mm) overall length
8 3/4" (222mm) knurled handle
60mm head diameter
72.5mm head length



OM 49-0770
9 3/4" (248mm)

WAGNER Mallet



OM 49-0771
1 pair of metal disks



OM 49-0772
1 pair of plastic disks



OM 49-0773
wrench



FEMORAL HEAD DRIVER

OM ZIM 9027-58
 6 3/4" w/removable concave nylon cap
 head diameter: 38mm
 lightweight aluminum handle

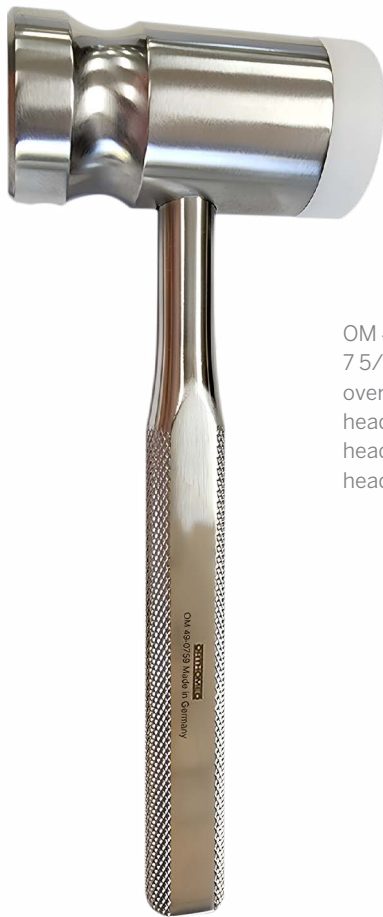

OM 49-0759
 7 5/8" overall length
 overall weight: 1.7 lbs
 head weight: 1.1 lbs
 head diameter: 38mm
 head length: 76mm

COMBINATION Mallet W/NYLON CAP



OM 12500
 9" (230mm) overall length
 weight: 1lb. 7oz (700 gr)
 head diameter: 40mm

BONE Mallet

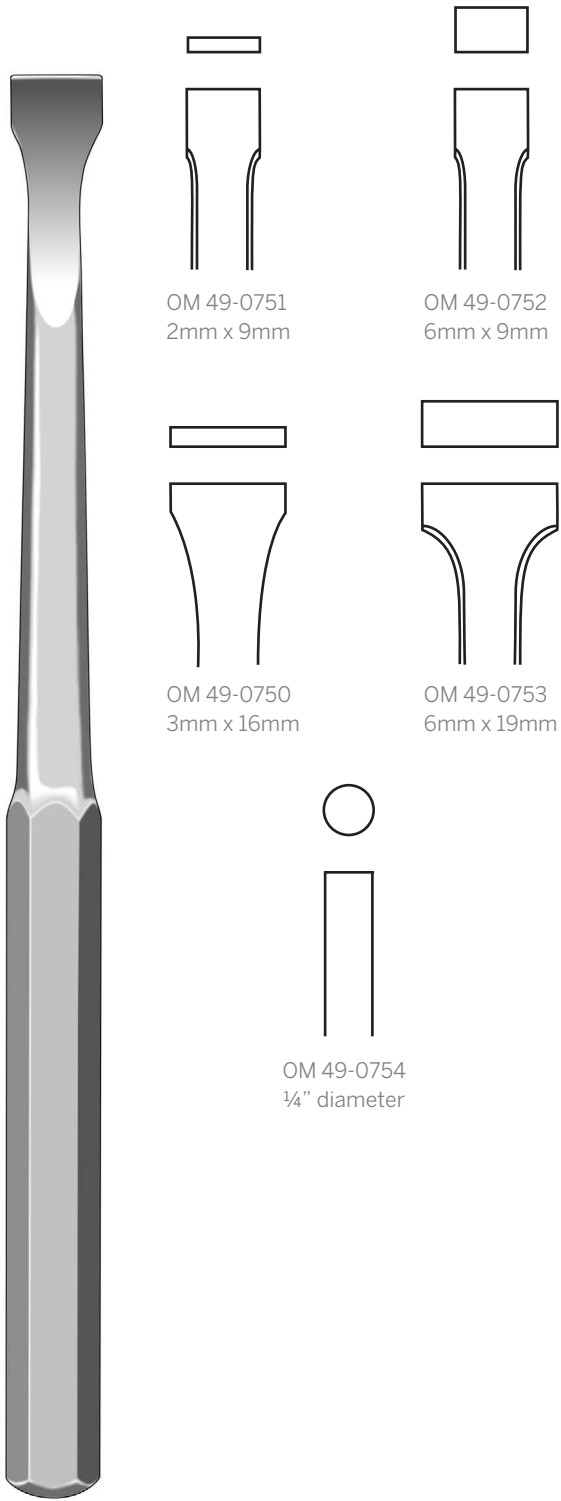

BONE CHIP PACKER
10" (254mm)

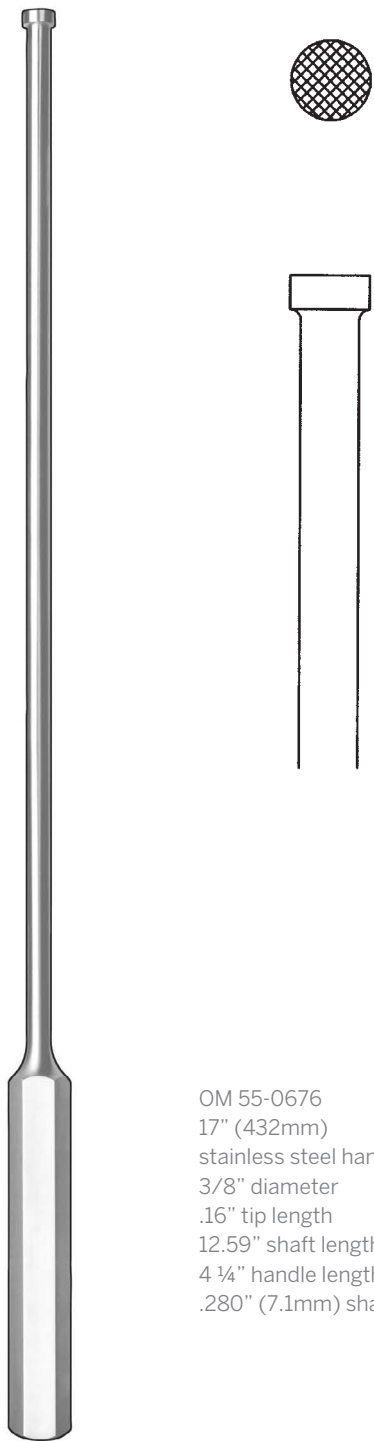

OM 55-0676
17" (432mm)
stainless steel handle
3/8" diameter
.16" tip length
12.59" shaft length
4 1/4" handle length
.280" (7.1mm) shaft diameter

BONE TAMP
Endoscopic

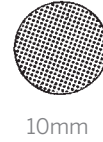

- | | |
|------------|---------------|
| OM 46-0893 | 2mm diameter |
| OM 46-0894 | 3mm diameter |
| OM 46-0895 | 4mm diameter |
| OM 46-0896 | 5mm diameter |
| OM 46-0897 | 6mm diameter |
| OM 46-0898 | 8mm diameter |
| OM 46-0899 | 10mm diameter |

BONE TAMP

With cross serrated tip
6" (152mm)

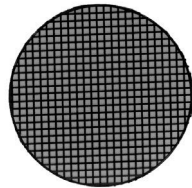
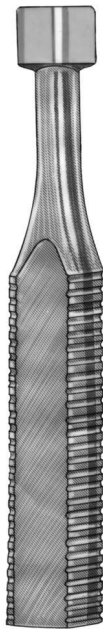

OM 69-0980P
replaceable nylon cap

Designed to tap bone graft or bone parts into place with minimal trauma to the bone. The compactor head is nylon with a grid surface to prevent slippage.

Autoclavable to 250° (121°C).

OM 69-0980
6 ½" (165mm)
with replaceable nylon caps
anodized aluminum handle
head diameter: 20mm

BONE IMPACTOR



OM 55-0370
6mm x 12mm

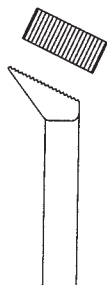

OM 55-0371
7mm x 16mm

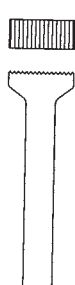

OM 55-0372
6mm x 13mm



OM 55-0373
4mm x 10mm

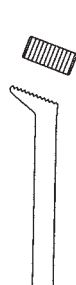

OM 55-0374
4mm x 10mm



OM 55-0375
10mm x 13mm



OM 55-0376
7mm x 13mm



OM 55-0377
10mm x 13mm



OM 55-0378
7mm x 13mm

| | | |
|------------|------|-----------------------------------|
| OM 55-0370 | 8 ½" | Impactor, standard offset |
| OM 55-0371 | 8 ½" | Impactor, central canal |
| OM 55-0372 | 8 ½" | Impactor, lateral narrow |
| OM 55-0373 | 7" | Impactor, micro offset |
| OM 55-0374 | 7" | Impactor, micro lateral |
| OM 55-0375 | 8 ½" | Graft Driver, lumbar, guarded |
| OM 55-0376 | 8 ½" | Graft Driver, anterior, guarded |
| OM 55-0377 | 8 ½" | Graft Driver, lumbar, unguarded |
| OM 55-0378 | 8 ½" | Graft Driver, anterior, unguarded |

LUMBAR AND CERVICAL IMPACTORS AND DRIVERS

Serrated tips



| | | |
|------------|--|------------------|
| OM 55-0384 | Bone Graft Holder / Impactor 6" (152mm) | Serr 3.2mm 1/8" |
| OM 55-0385 | Bone Graft Holder / Impactor 6" (152mm) | Serr 4.8mm 3/16" |
| OM 55-0386 | Bone Graft Holder / Impactor 6" (152mm) | Serr 6.4mm 1/4" |
| OM 55-0387 | Bone Graft Holder / Impactor 6" (152mm) | Serr 7.9mm 5/16" |
| OM 55-0388 | Bone Graft Holder / Impactor 10" (254mm) | Serr 3.2mm 1/8" |
| OM 55-0389 | Bone Graft Holder / Impactor 10" (254mm) | Serr 4.8mm 3/16" |
| OM 55-0390 | Bone Graft Holder / Impactor 10" (254mm) | Serr 6.4mm 1/4" |
| OM 55-0391 | Bone Graft Holder / Impactor 10" (254mm) | Serr 7.9mm 5/16" |

BONE TAMP

With cross serrated tip
6" (152mm)